

Resonant Structures due to Planets

The background is a deep space scene. A bright, white star is the central focus, with a lens flare effect. To the left, a blue planet with prominent rings is shown. To the right, a smaller, yellowish planet is visible. The background is filled with a dense field of stars and a nebula with soft, glowing colors. The overall tone is dark and cosmic.

Mark Wyatt

UK Astronomy Technology Centre
Royal Observatory Edinburgh

HARDY

Gravitational Perturbations of Unseen Planet

It is the effect of a planet's gravity on the orbits of planetesimals and dust in a debris disk which causes structure in it.

The effect of a planet's gravity can be divided into two groups (e.g., Murray & Dermott 1999)

- **Secular Perturbations**
- **Resonant Perturbations**

Both are the consequence of Newton's $F = GM_{\text{dust}}M_{\text{pl}}/r^2$ law of gravitation

Secular Perturbations

Are the long term effect of the planet's gravity and act on all disk material over >0.1 Myr timescales

Cause the disk to be:

- **Offset**
if the planet has an eccentric orbit

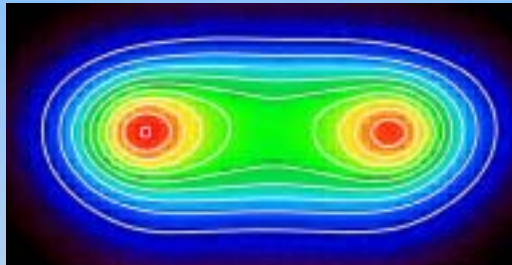

e.g., lobe brightness asymmetry in HR4796 disk (Wyatt et al. 1999; Telesco et al. 2000)

- **Warped**
if the planet has an inclined orbit

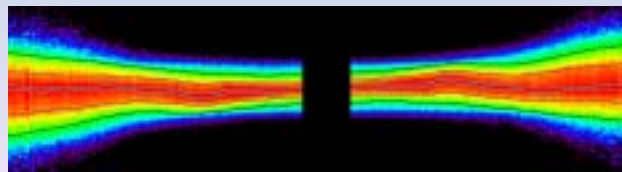

e.g., warp in β Pictoris disk (Heap et al. 2000; Augereau et al. 2001)

Resonant Perturbations

- Affect only material at specific locations in the disk where the dust or planetesimals orbit the star with a period which is a ratio of two integers times the orbital period of the planet...

$$P_{\text{res}} = P_{\text{planet}} * (p+q)/p$$

...which from Kepler's law gives

$$a_{\text{res}} = a_{\text{planet}} * [(p+q)/p]^{2/3}$$

- Resonant material receives periodic kicks from the planet which always occur at the same place(s) in its orbit, which can be a good or a bad thing!

Cause the disk to contain:

- **Gaps**
- **Clumpy Rings**

Chaotic Resonances

- Some resonances are chaotic and planetesimals are quickly ejected from these regions of parameter space
- e.g., the Kirkwood Gaps in the asteroid belt associated with Jupiter's resonances

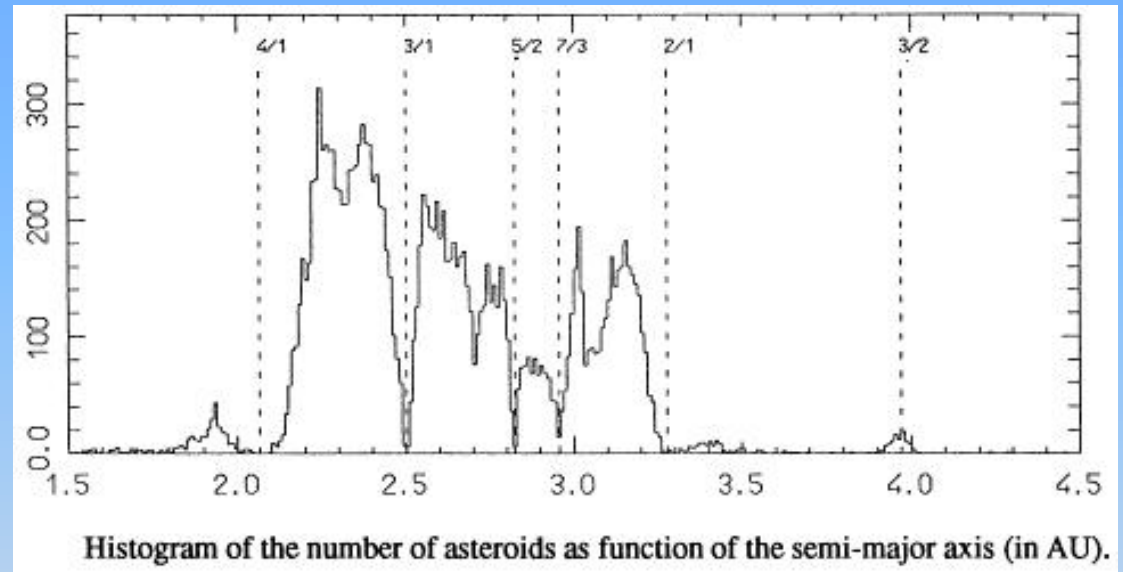

Moons (1997)

Individual resonances cause gaps in semimajor axis distribution, but not radial distribution

Resonance Overlap

- Close to a planet the resonances overlap creating a chaotic zone rapidly depleted of planetesimals
- This zone covers a region (Wisdom 1980):

$$a_{pl} [1 \pm 1.3 (M_{pl}/M_{star})]^{2/7}$$

Orbital stability in the outer solar system

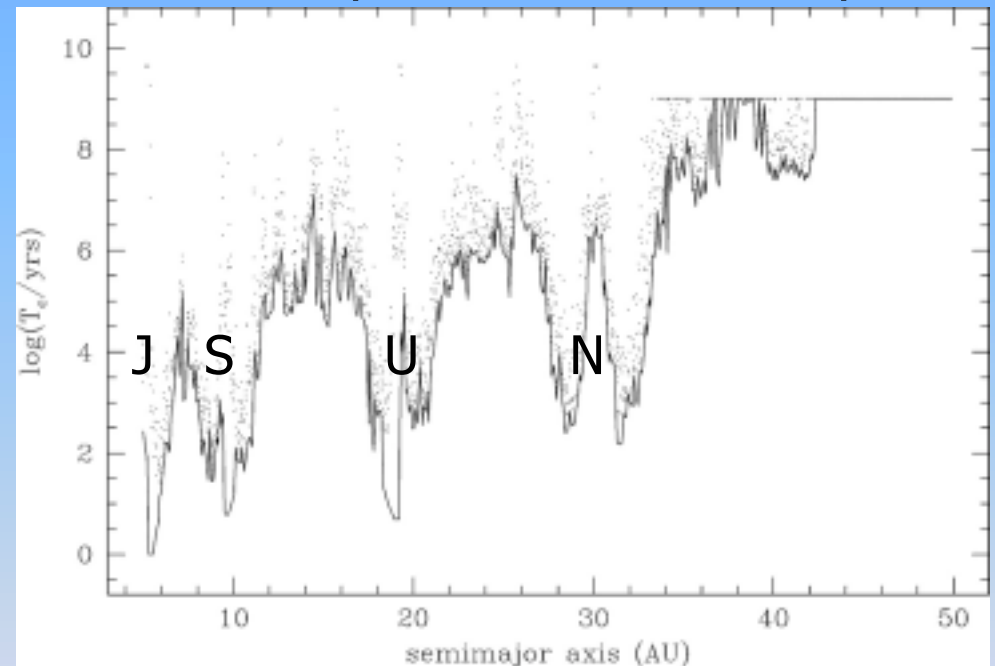

Lecar et al. (2001)

Resonance overlap causes gaps along orbits of the planets

Mechanisms for Filling Resonances

While some resonances are very stable, they occupy a small region of parameter space.

Resonances are filled for two reasons:

- **Inward migration of dust**
Dust spirals in toward the star due to P-R drag and resonances temporarily halt inward migration
- **Outward migration of planet**
Planet migrates out and planetesimals are swept into the planet's resonances

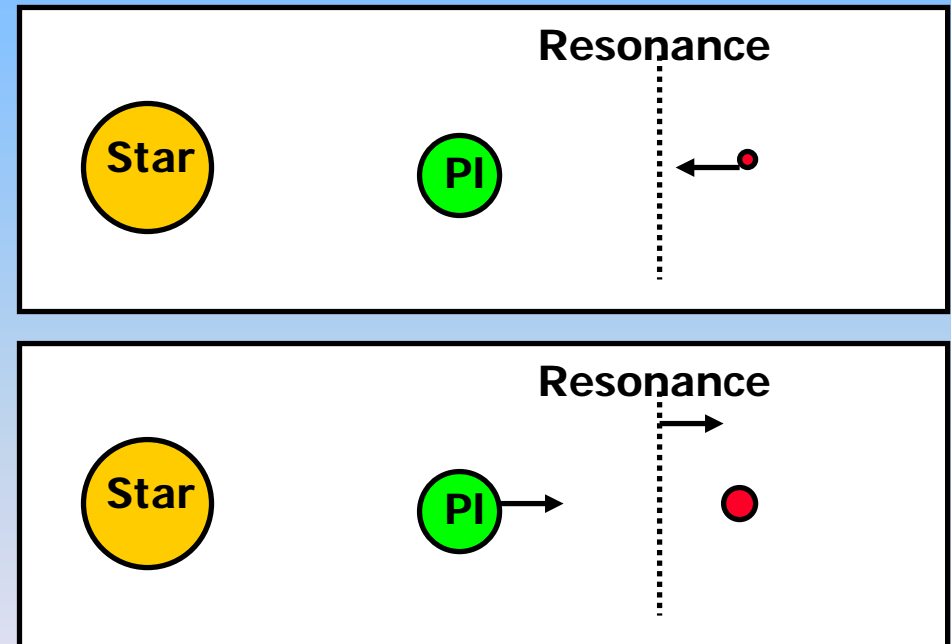

Resonant filling causes a ring to form along the planet's orbit

Dust Migration into Resonance with Earth and Neptune

Dust created in the asteroid belt spirals in toward the Sun over 50 Myr, but resonant forces halt the inward migration...

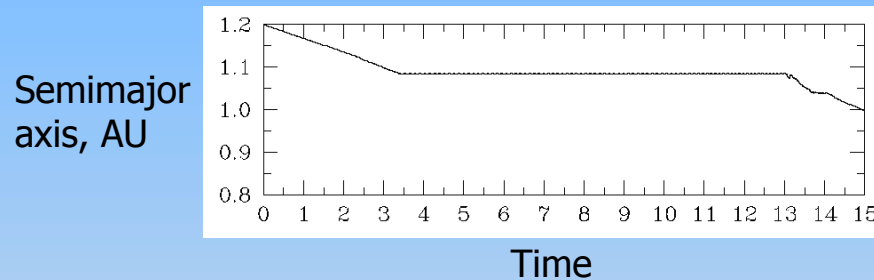

...causing a ring to form along the Earth's orbit

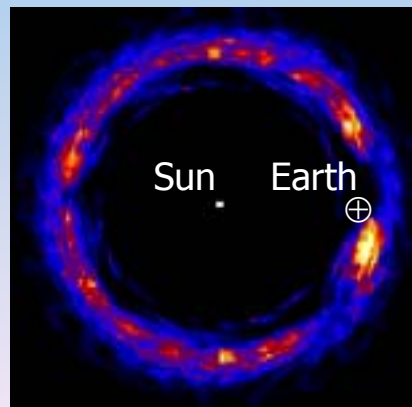

Dermott et al. (1994)

Dust created in the Kuiper Belt also migrates inward because of P-R drag and an equivalent ring is predicted to form along Neptune's orbit

Kuiper Belt dust distribution

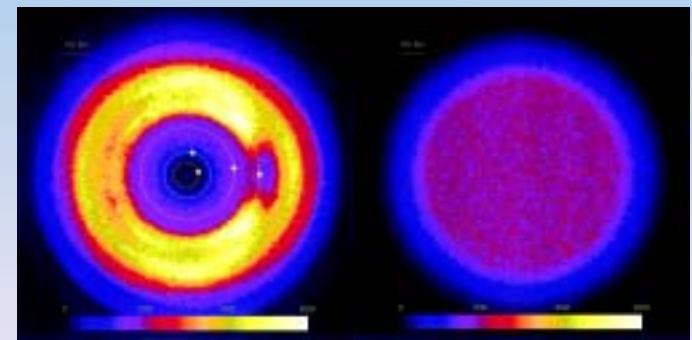

With and

Without Planets

Liou & Zook (1999)

Resonant Structure in the Kuiper Belt

Many Kuiper Belt objects (including Pluto) are found today in Neptune's 3:2, 2:1, 5:3, 4:3 resonances:

This is explained by the scattering of remnant $50M_{\text{earth}}$ planetesimal disk which caused Neptune to migrate 23-30 AU over 50 Myr:

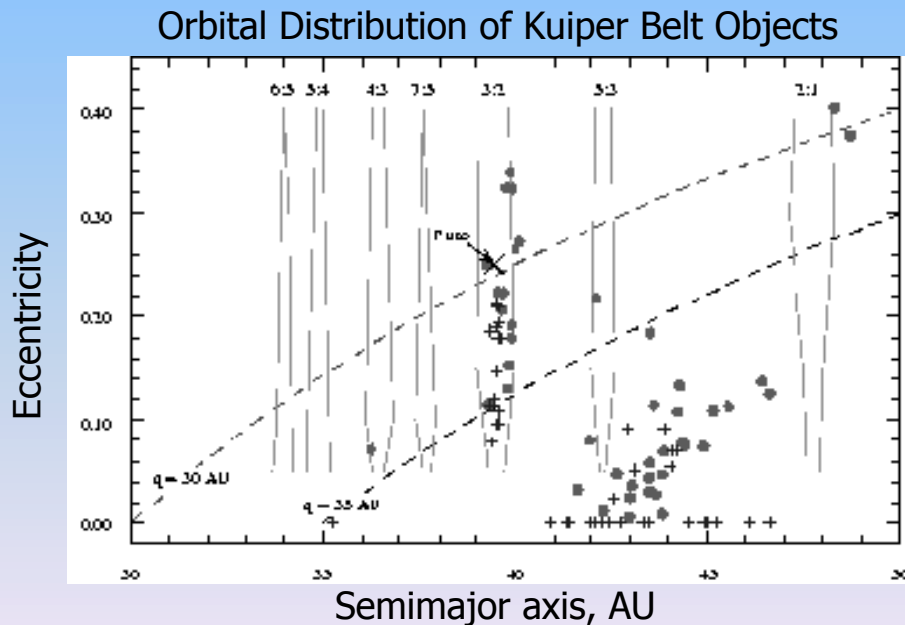

Jewitt (1999)

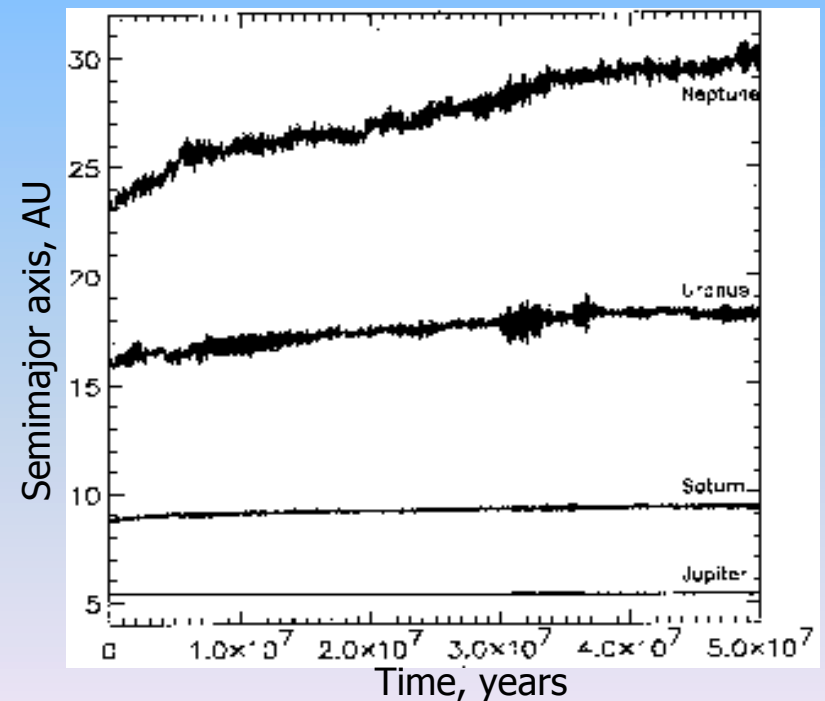

Hahn & Malhotra (1999)

3:2 Resonance - A comet in 3:2 resonance orbits the star twice for every three times that the planet orbits the star.

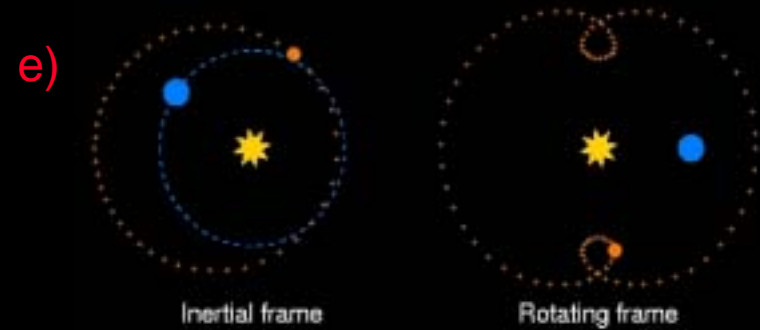
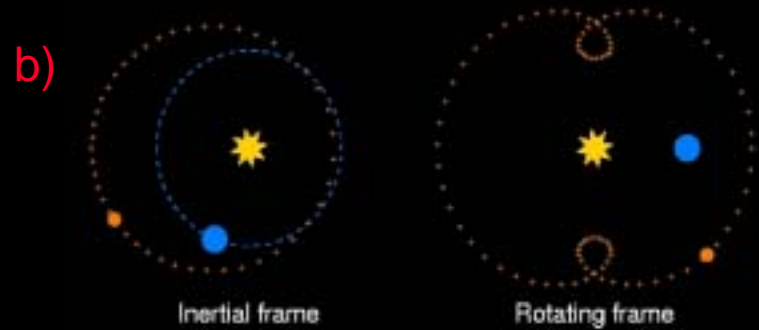
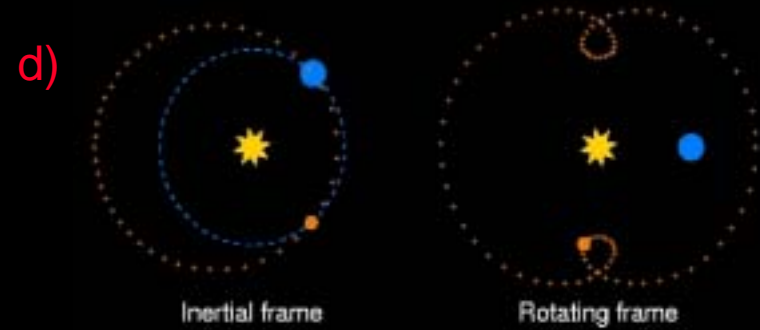
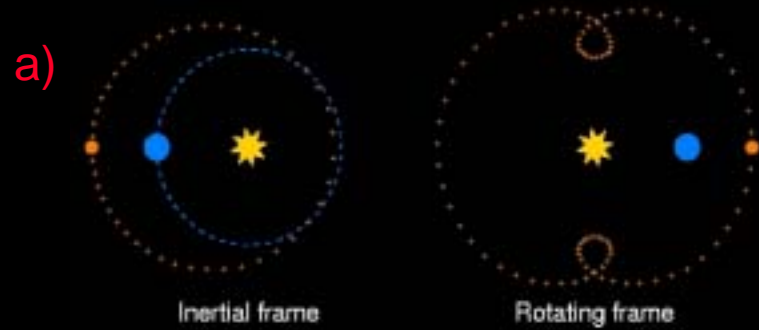

● Planet
● Comet in 3:2 resonance

3:2 Resonance - This means that the comet spends most of its time at 2 locations relative to the planet.

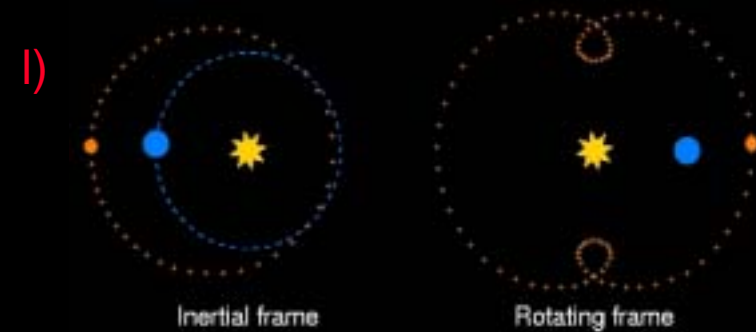
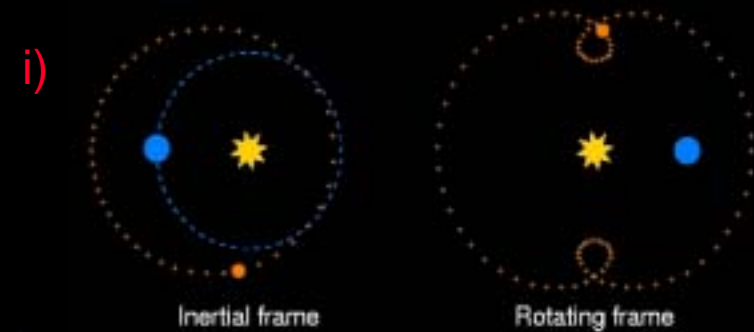
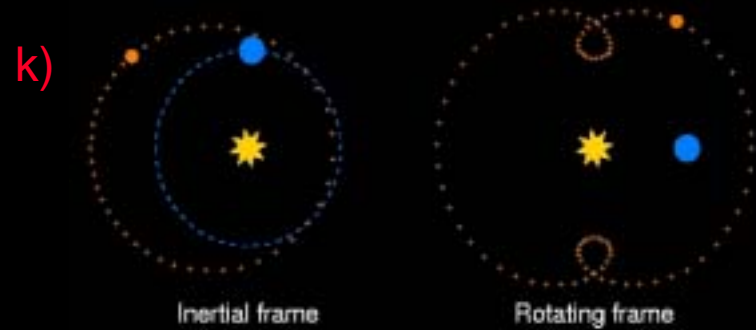
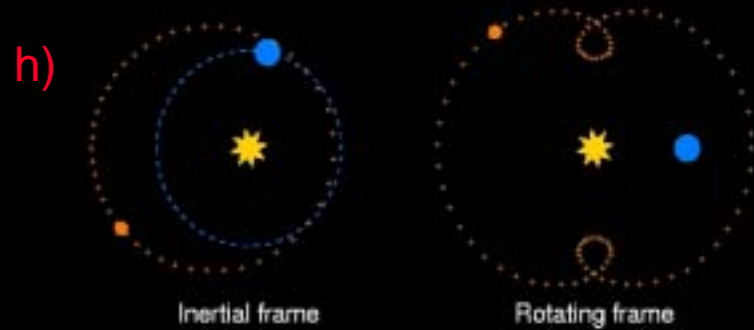
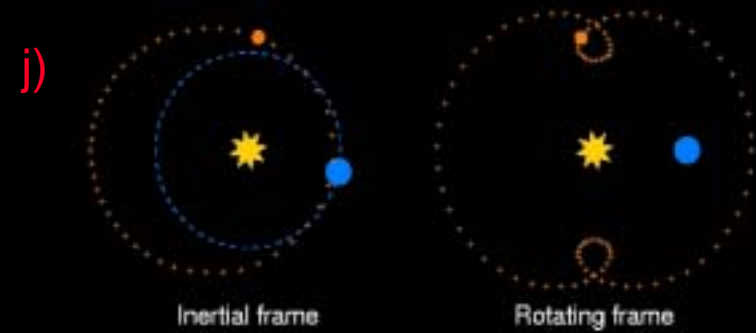
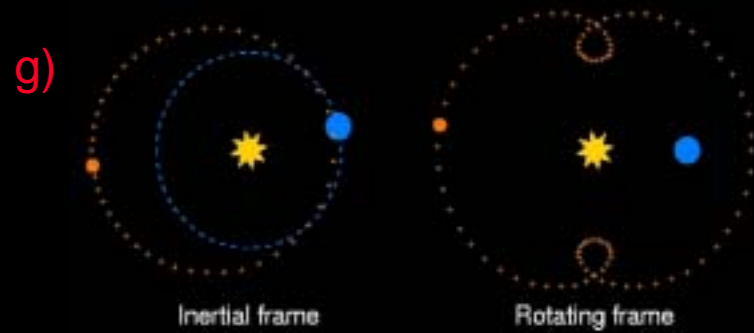

● Planet
● Comet in 3:2 resonance

Geometry of Resonances

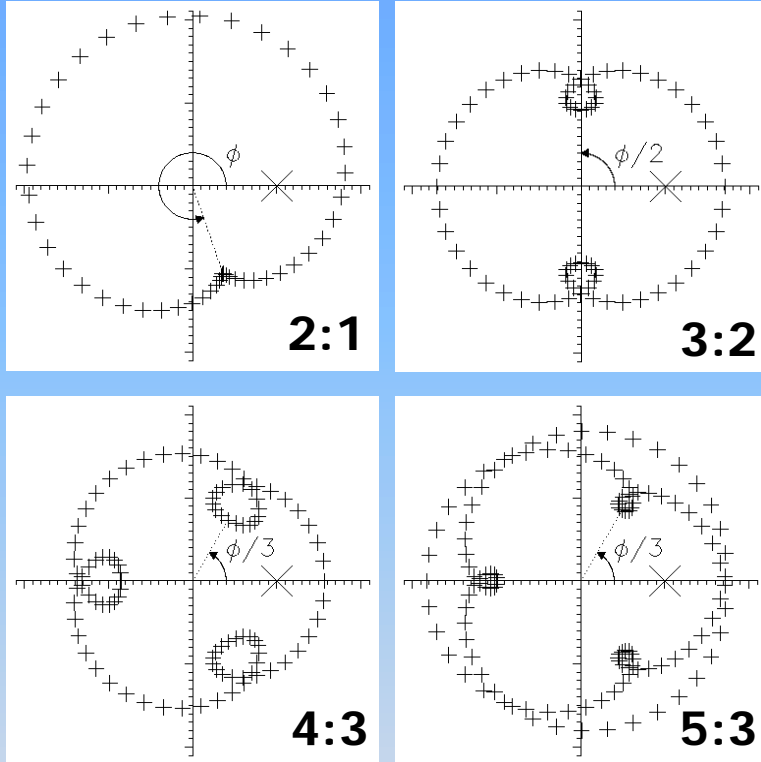

Paths of resonant orbits at equal timesteps in frame rotating with the planet (X) for $e=0.3$

Each resonance has its own geometry so that, e.g., the pattern formed by material in

2:1 is one clump

3:2 is two clumps

4:3 and **5:3** is three clumps

which follow(s) the planet around its orbit

Detailed dynamics: resonant forces cause resonant argument ϕ to librate

$$\phi = (p+q)\lambda_r - p\lambda_{pl} - q\varpi_r$$

$$\phi = \phi_m + \Delta\phi \sin(t/t_\phi)$$

The clumpy patterns of extrasolar resonant rings will be determined by the extent to which different resonances are filled

Resonant trapping in the β Pictoris Disk

Roques et al. (1994) showed a wide variety of clumpy structures form by dust migration into resonance:

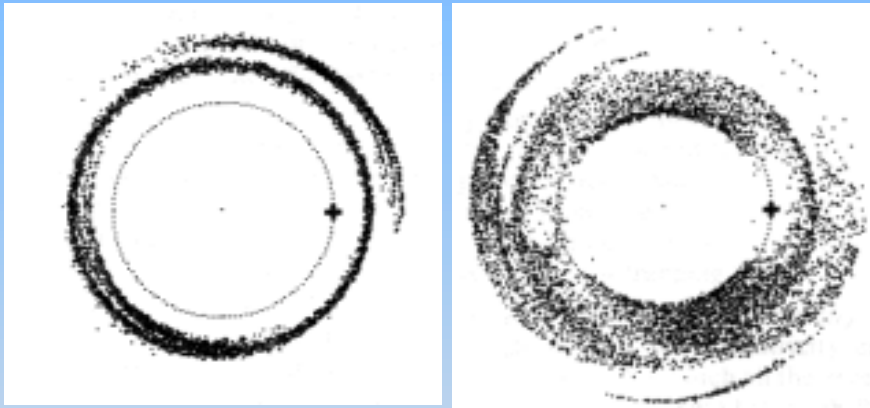

They used this result to explain the inner hole in the β Pictoris disk by a planet at 20 AU:

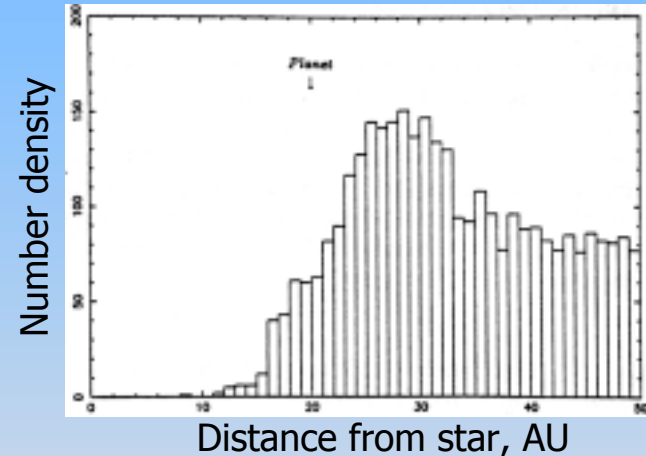

Resonant trapping is more efficient for larger planets, implying to form a gap the planet must be $>5M_{\text{earth}}$

Clumpy Debris Disks

Observations show that **many debris disks are characterized by clumpy rings**

Vega

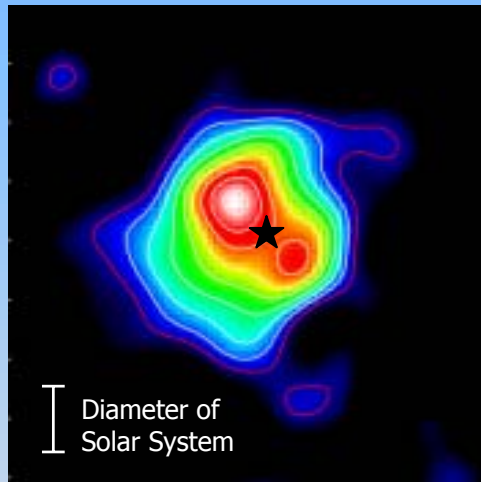

Holland et al. (1998)

Fomalhaut

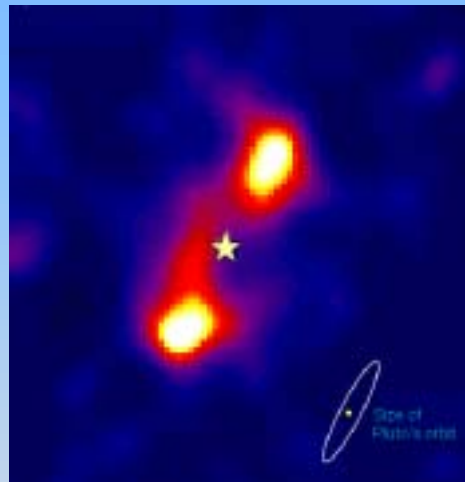

Holland et al. (2003)

ϵ Eridani

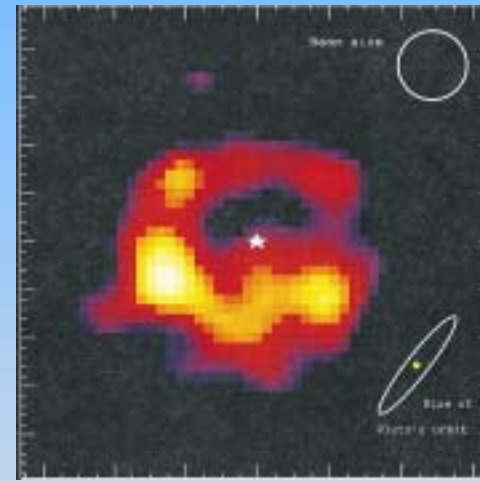

Greaves et al. (1998)

The only viable explanations for this clumpiness involve planetary resonances

Trapping with Planets on Circular Orbits

Ozernoy et al. (2000) showed that Vega's and ϵ Eridani's clumpy disks could be explained by dust migrating into a planet's resonances. They predicted planet locations/masses and orbital motion of the dust structures.

Vega

Planet:

$2 M_{\text{Jupiter}}$
 $a = 50\text{-}60 \text{ AU}$
low eccentricity

Dust:

$\beta = 0.3$
 $n:1$ resonances
 $1.2\text{-}1.6 \text{ }^\circ/\text{yr}$
(orbits with pl)

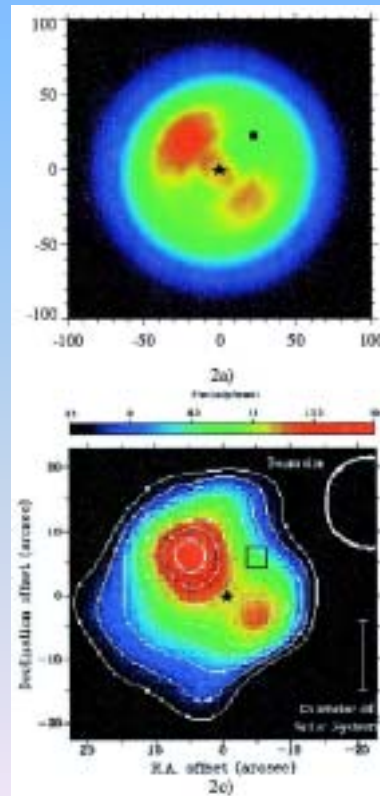

ϵ Eridani

Planet:

$0.2 M_{\text{Jupiter}}$
 $a = 55\text{-}65 \text{ AU}$
low eccentricity

Dust:

$\beta = 0.002$
 $3:2$ and $2:1$
resonances
 $0.6\text{-}0.8 \text{ }^\circ/\text{yr}$
(orbits with pl)

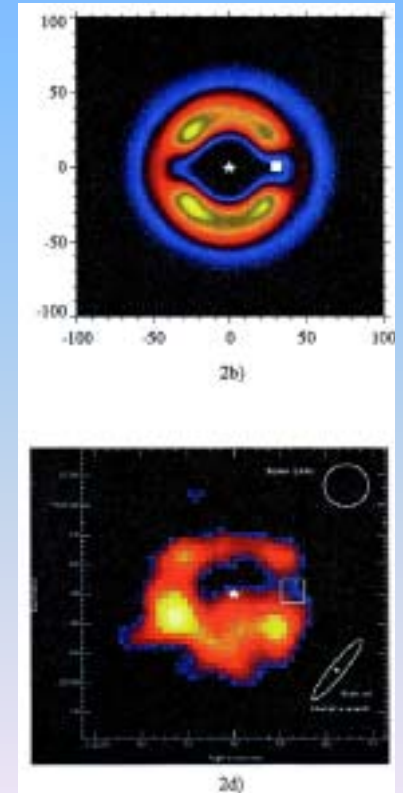

Trapping with Planets on Eccentric Orbits

Wilner et al. (2002) proposed an alternative model for Vega involving a massive planet on an eccentric orbit

Vega

Planet:

$3 M_{\text{Jupiter}}$
 $a = 40 \text{ AU}$
 $e = 0.6$

Dust:

$\beta = 0.01$
 $n:1$ resonances
 $\frac{1}{2}$ orbital speed planet

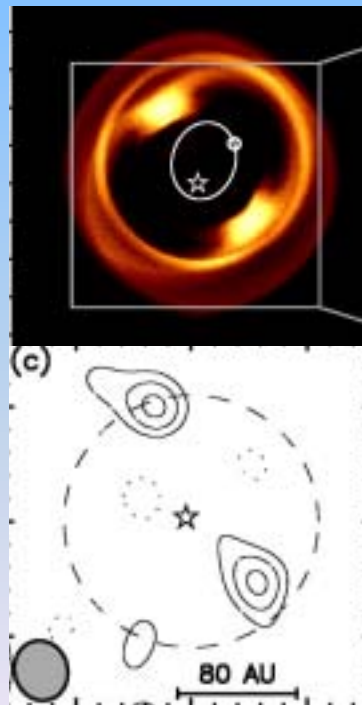

Quillen & Thorndike (2002) also proposed a model involving an eccentric planet around ϵ Eridani

ϵ Eridani

Planet:

$0.1 M_{\text{Jupiter}}$
 $a = 40 \text{ AU}$
 $e = 0.3$

Dust:

$\beta = 0.1$
 $5:3$ and $3:2$
resonances
 $1.3 \text{ }^\circ/\text{yr}$
orbit with planet

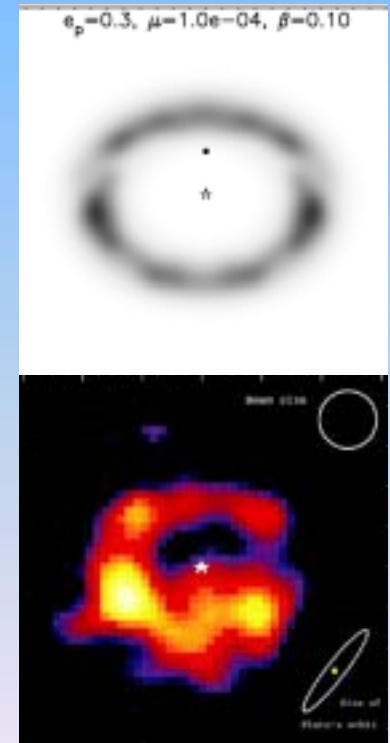

Timescale Problem

Dust grains in a dense disk do not migrate far from their source due to P-R drag before being destroyed in a collision with another dust grain (Wyatt et al. 1999)

- Collisional timescale: $t_{\text{coll}} = r^{1.5} / 12 M_{\text{star}}^{0.5} \tau$ (0.1-1 Myr for Vega)
- P-R drag timescale: $t_{\text{pr}} = 400 r^2 / M_{\text{star}} \beta$ (>2 Myr for Vega)

This means that mass flows through the collisional cascade in Vega's disk and is removed by radiation pressure NOT P-R drag

P-R drag is unimportant for dense disks where

$$\tau > 10^{-4} (M_{\text{star}}/r)^{0.5}$$

Summarizing Dust Migration Structures

Kuchner & Holman (2003) summarized the four types of dust structure expected when dust migrates into the resonances of high/low mass planets that are on eccentric/circular orbits:

I low mass, low eccentricity

e.g., Dermott et al. (1994),
Ozernoy et al. (2000) ϵ Eri

II high mass, low eccentricity

e.g., Ozernoy et al. (2000) Vega

III low mass, high eccentricity

e.g., Quillen & Thorndike (2002)

IV high mass, high eccentricity

e.g., Wilner et al. (2002), Moran et al. (2004)

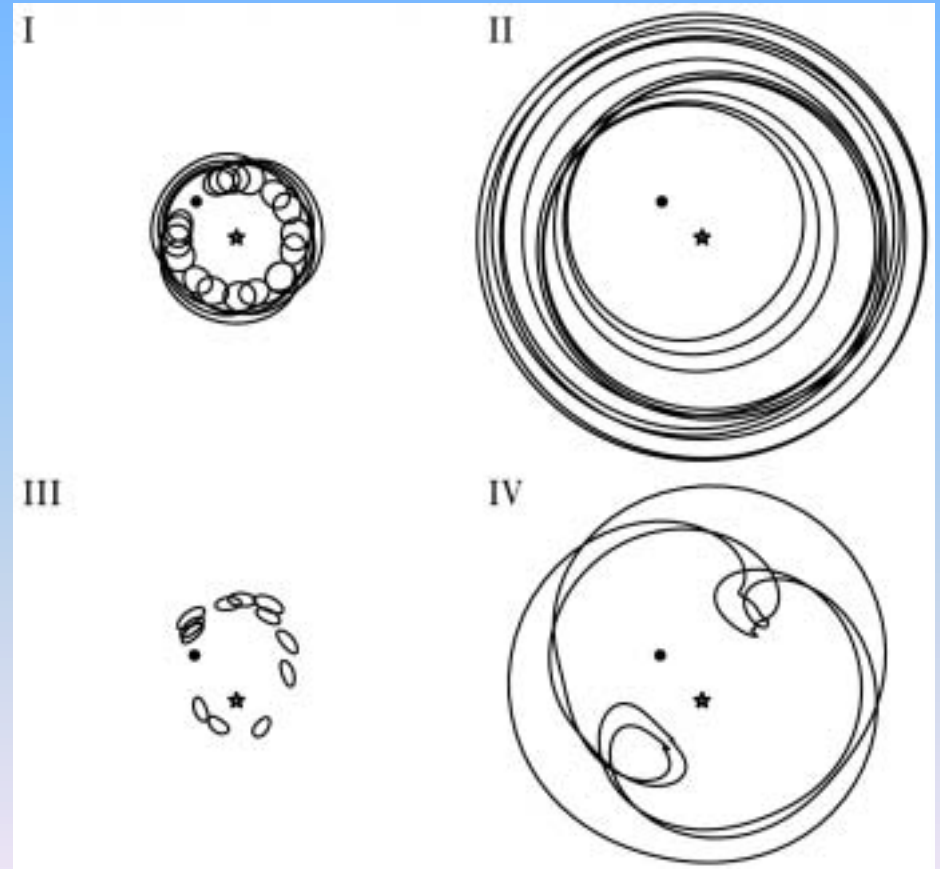

Vega: Evidence of Planet Migration

- Wyatt (2003) explained Vega's two asymmetric clumps by the migration of a $17M_{\text{earth}}$ planet from 40-65AU in 56 Myr
- Most planetesimals end up in the planet's 2:1(u) and 3:2 resonances

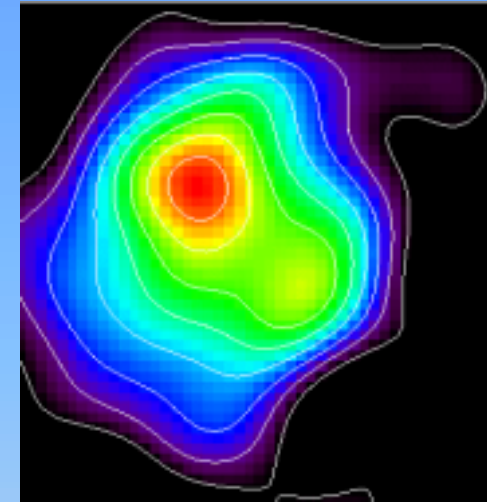

Observed

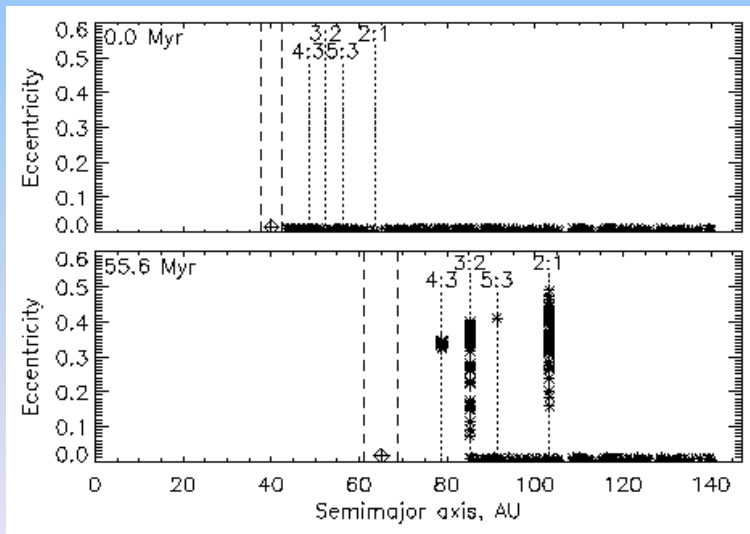

Orbit Distribution

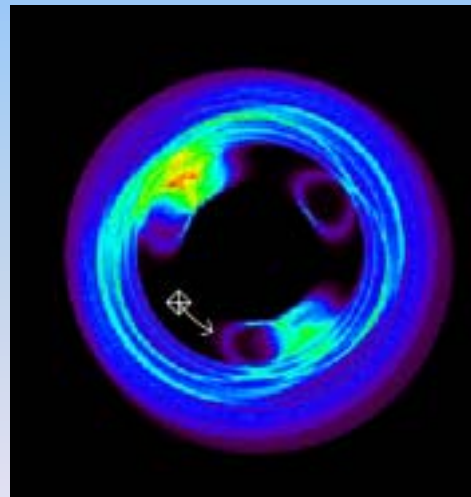

Spatial Distribution

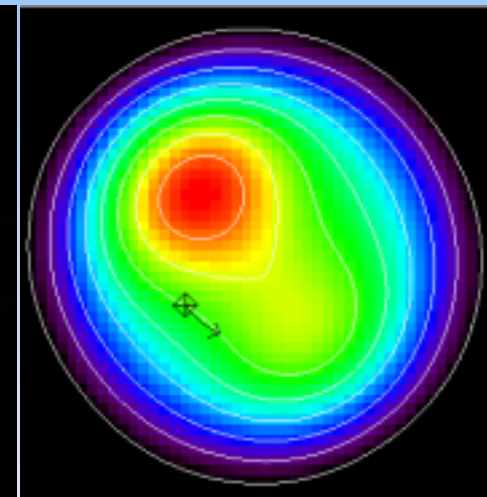

Model

Emission Distribution

The outward migration of a Neptune mass planet (●) around Vega sweeps many comets (*) into the planet's resonances

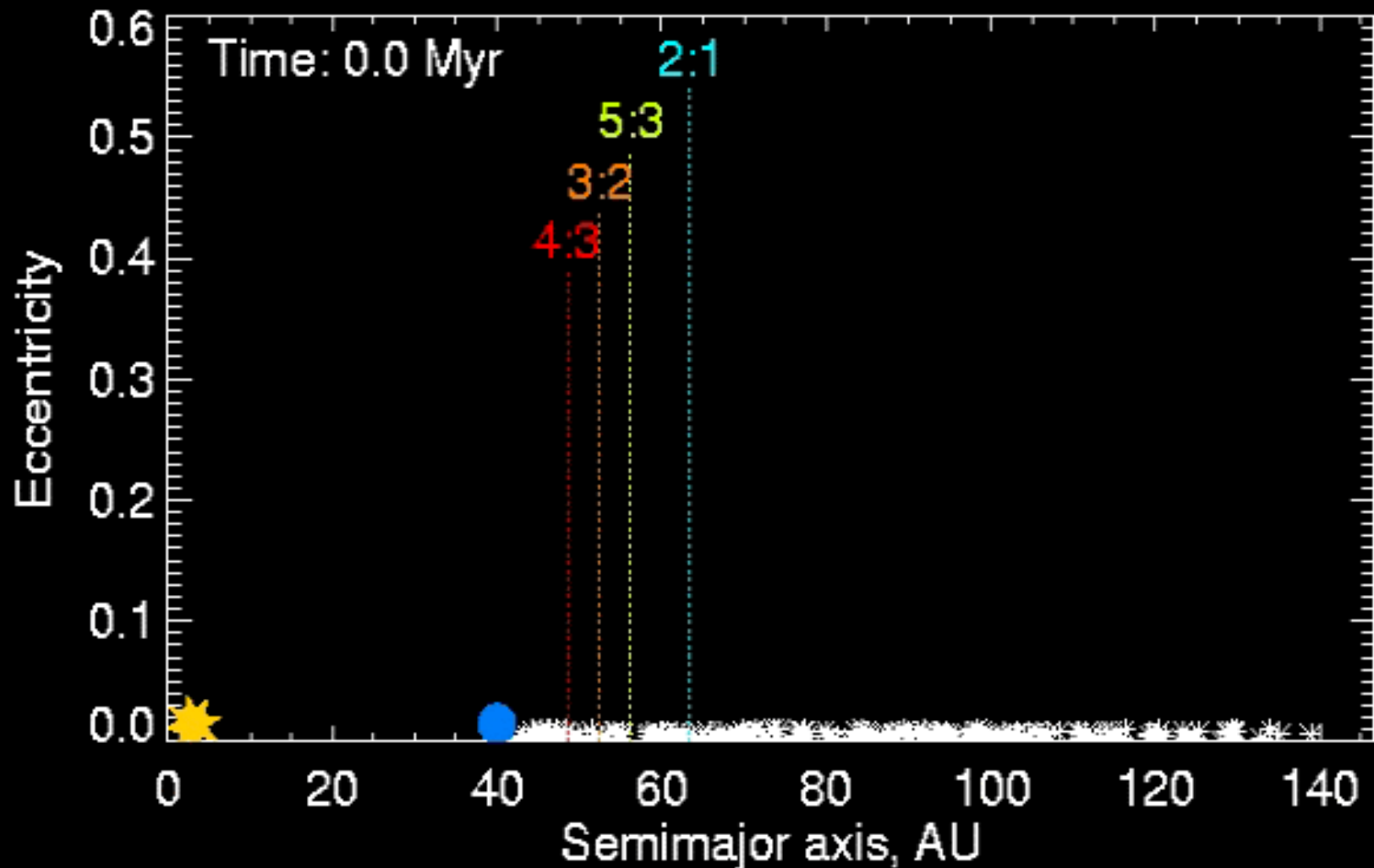

The outward migration of a Neptune mass planet (●) around Vega sweeps many comets (*) into the planet's resonances

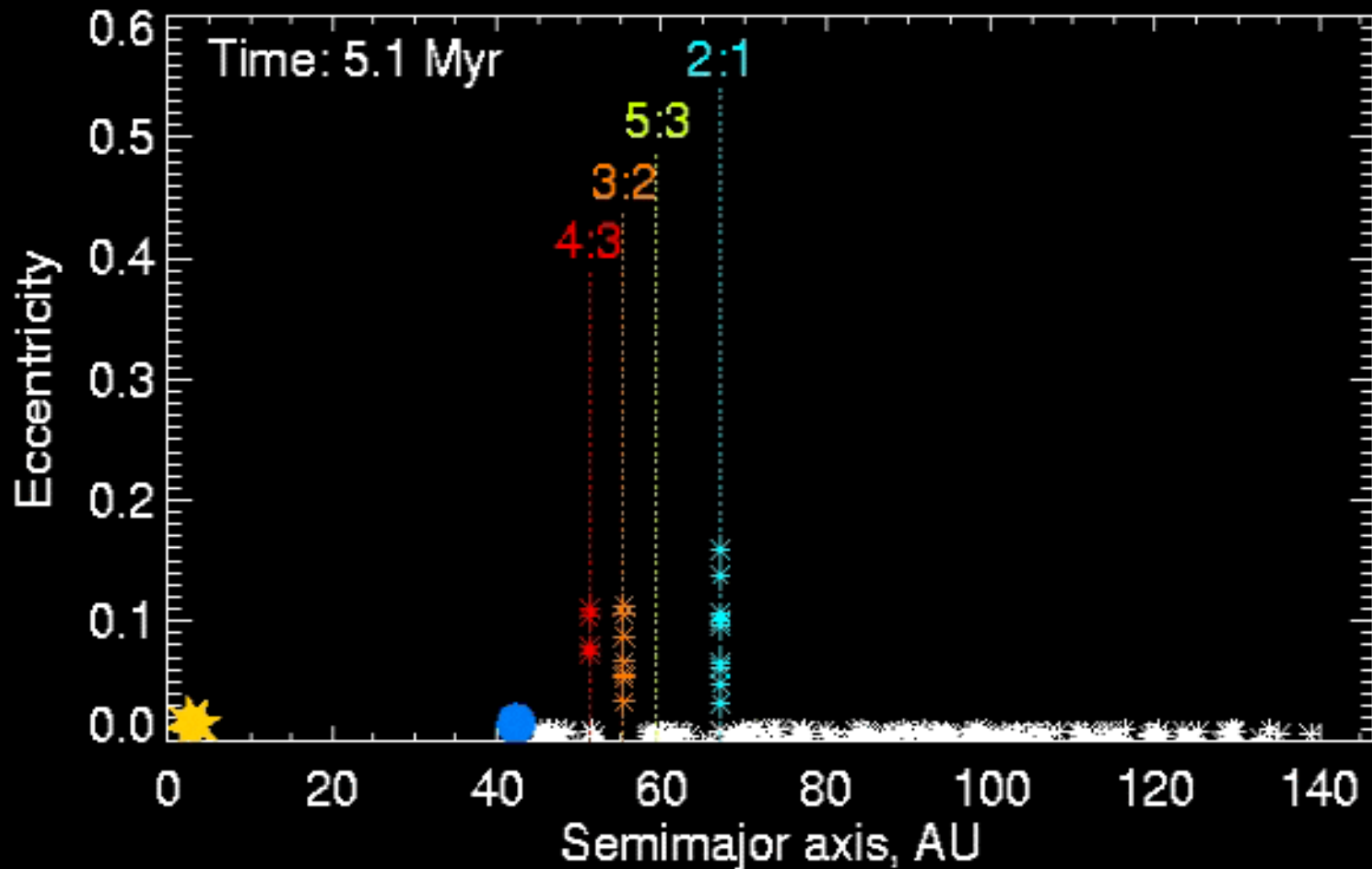

The outward migration of a Neptune mass planet (●) around Vega sweeps many comets (*) into the planet's resonances

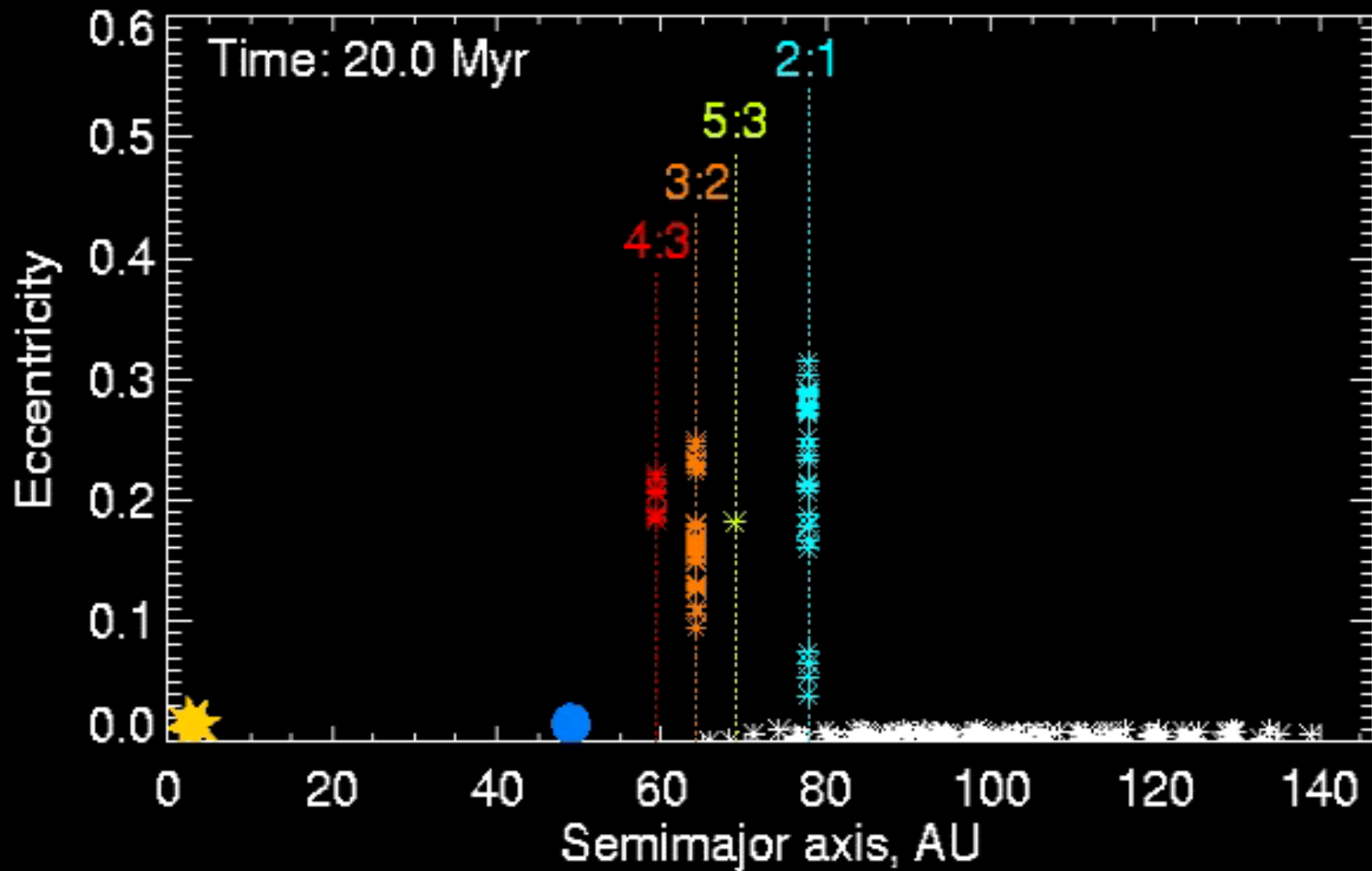

The outward migration of a Neptune mass planet (●) around Vega sweeps many comets (*) into the planet's resonances

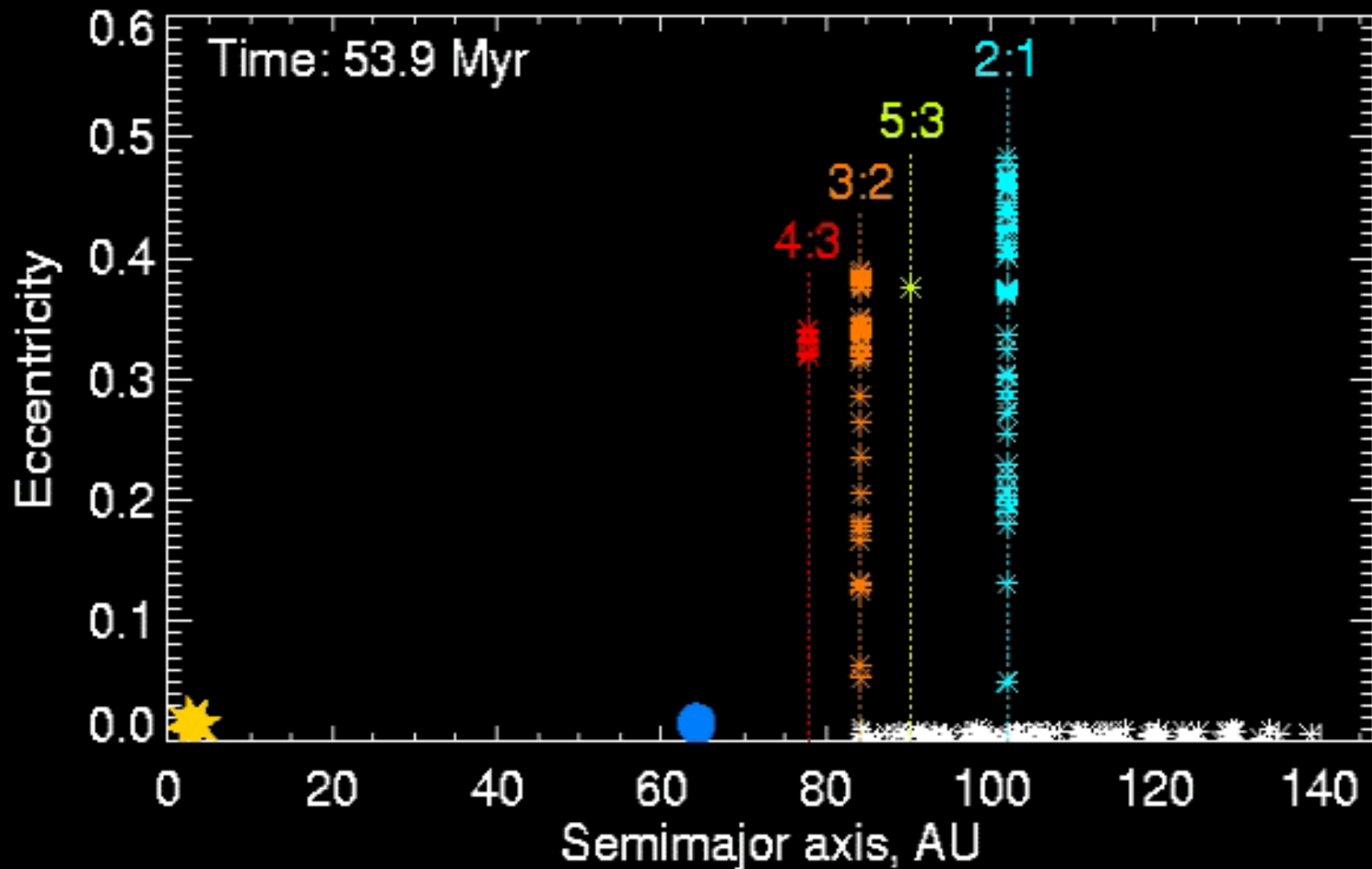

Time: 0.0 Myr

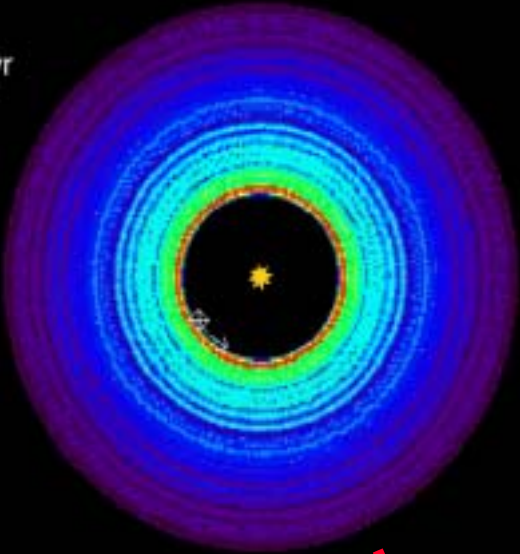

Time: 54.3 Myr

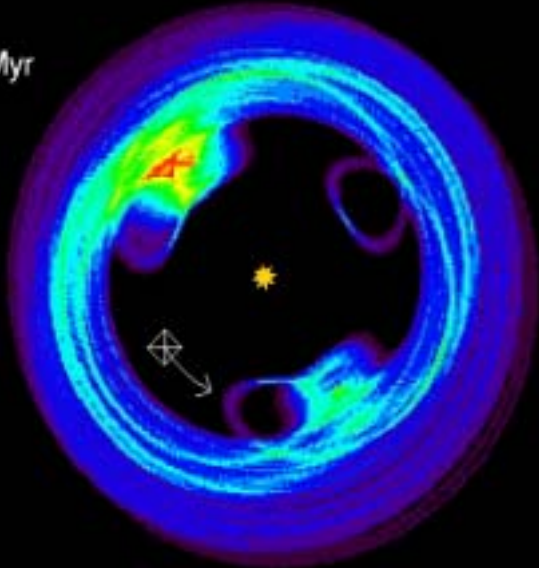

The trapping of comets in Vega's disk into planetary resonances causes them to be most densely concentrated in a few clumps

Time: 5.1 Myr

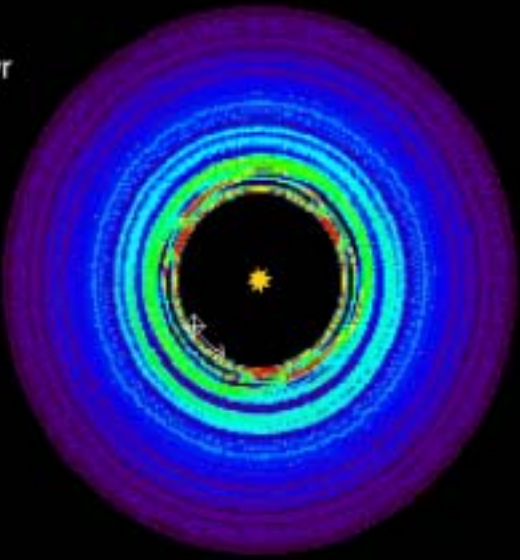

Time: 20.7 Myr

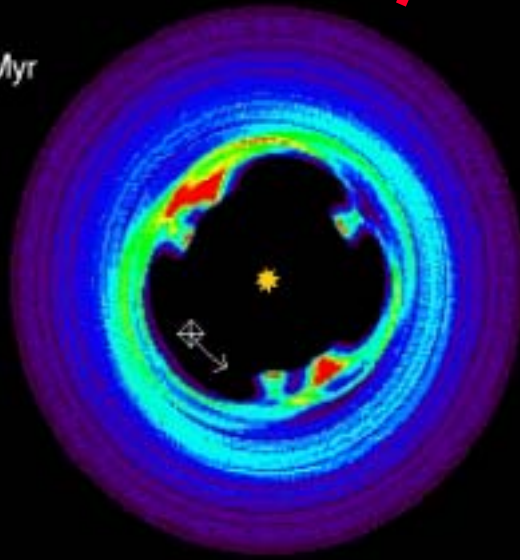

Implications of Planet Migration Model

- Tight constraints set on possible ranges of planet mass and migration rate

Planet
Migration
Rate

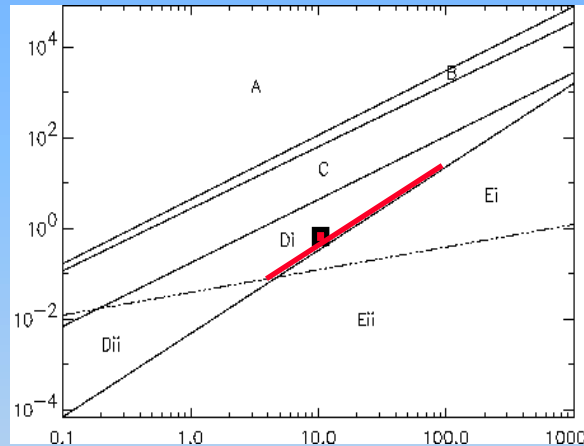

Planet mass

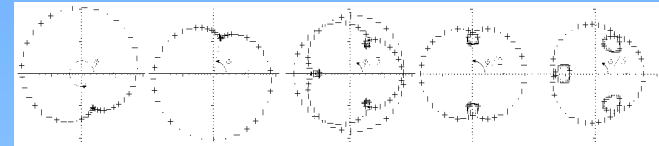

Zone	2:1(u)	2:1(l)	5:3	3:2	4:3
A	-	-	-	-	-
B	-	-	-	-	Y
C	-	-	-	Y	Y
Di	Y	-	-	Y	Y
Dii	Y	Y	-	Y	Y
Ei	Y	-	Y	Y	Y
Eii	Y	Y	Y	Y	Y

- Similar formation and evolution of Vega's system to solar system
- Prediction of 1.1 °/yr orbital motion with the planet 75° in front of motion of NE clump, and the presence of low level structure

Small Dust from 3:2 Resonant Planetesimals

- Small dust grains, as soon as they are created, see a less massive star due to radiation pressure, which changes their orbital period
- Numerical simulations have shown that:
 - **large particles stay in resonance**, but one with an increased libration width, hence smearing out the clumps
 - **small particles fall out of resonance**
- For the 3:2 resonance:

$$\beta_{\min} = 0.02 (M_{\text{pl}}/M_{\text{star}})^{0.5}$$

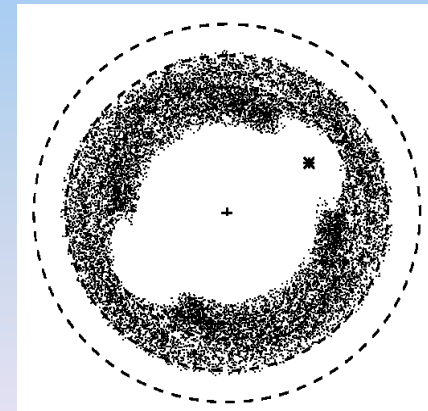
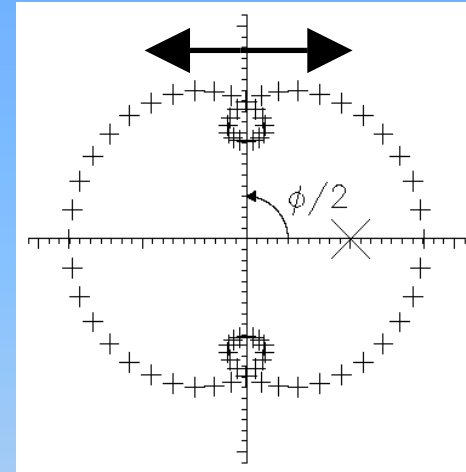

Small Dust from 2:1 Resonant Planetesimals

- The result is similar for dust from planetesimals in the 2:1 resonance, except that libration of ϕ is no longer sinusoidal
- The effect of clump smearing, then falling out of resonance, for smaller grains, is still the same:

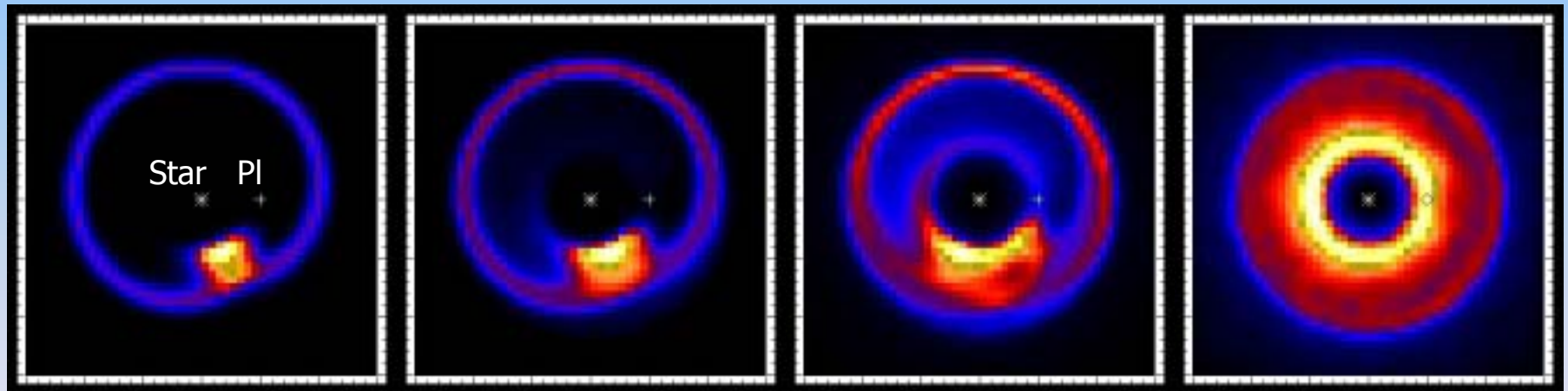

Planetesimals

Large Dust

Medium Dust

Small Dust

Implications for Vega's Clumpy Disk

Question: what size of grains are we seeing toward Vega?

Answer: using the Sheret et al. (2004) model which fitted the disk's SED assuming a collisional cascade size distribution shows which grain sizes contribute to the flux in each waveband:

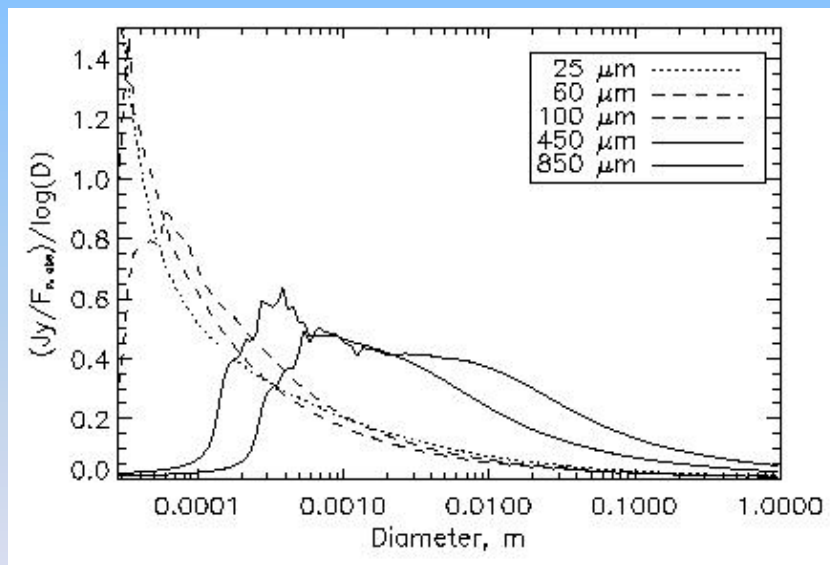

90% of the emission comes from grains of size

25 μm : <2-4 mm

60 μm : <2-4 mm

100 μm : <2-4 mm

450 μm : 160 μm – 8 cm

850 μm : 320 μm – 20 cm

Since the size cut-off for resonance is 300 μm – 2 mm, I predict:

sub-mm images will be clumpy; mid and far-IR images will be smooth

Conclusions of Small Dust Grains Study

- Small grains have different dynamics to large grains and so have different spatial distributions (with larger grains having clumpier distributions)
- Observations in different wavebands probe different grain sizes and therefore should see different structures, with a disk appearing smoother at shorter wavelengths
- By comparing observations in different wavelength regimes we can derive the size distribution and information about the planet mass

Dust Ring around η Corvi

We recently imaged the dust ring around the 1Gyr old F2V star η Corvi using SCUBA:

Wyatt et al. (submitted to ApJ)

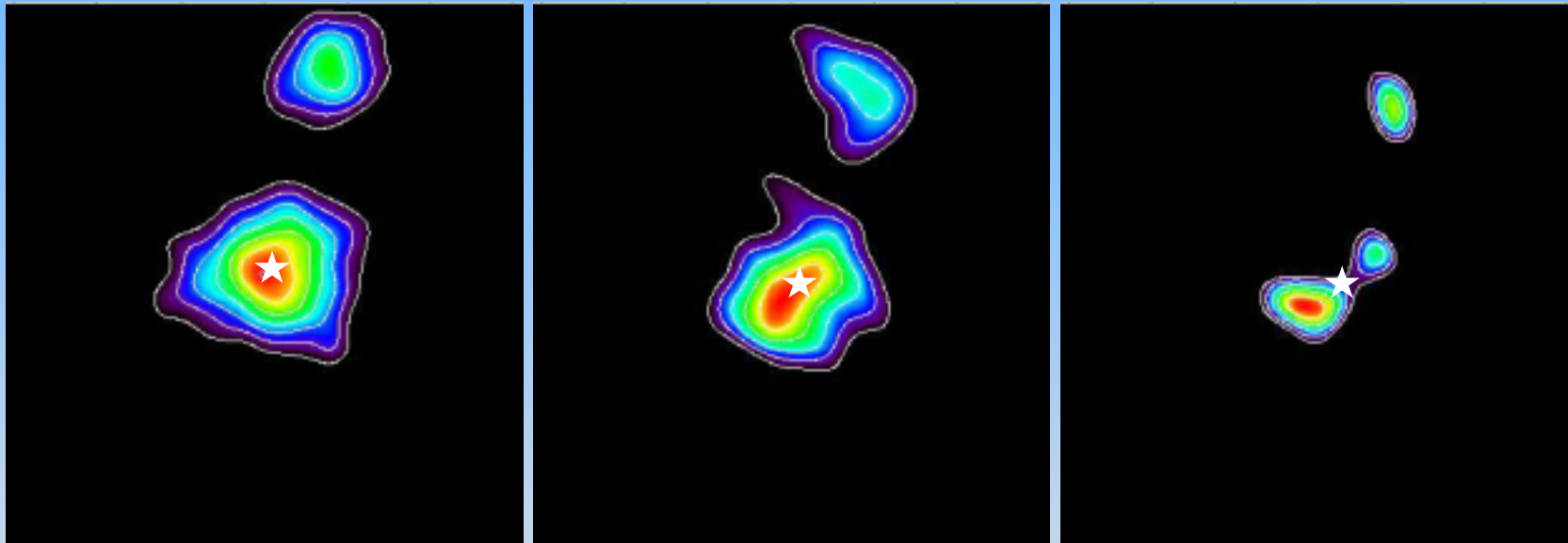

850 μm (15.8'')

450 μm (13.7'')

450 μm (9.5'')

The images show a clumpy dust ring of 150 AU radius with a background object to the NW.

Similarity to Vega's Clumpy Disk

The morphology is similar to Vega's clumpy disk and can be interpreted in a similar way to Wyatt (2003):

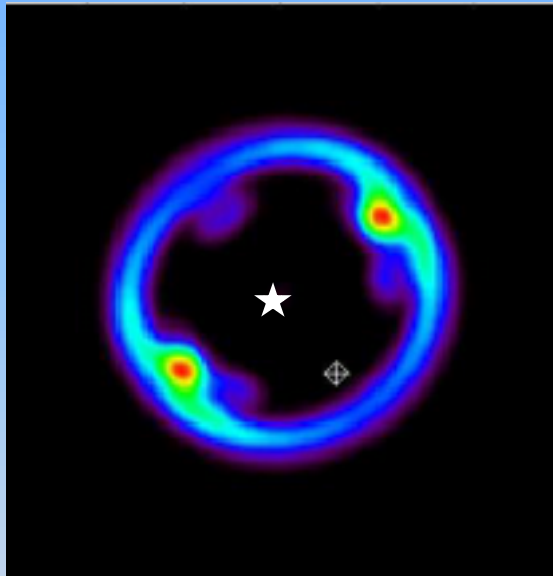

450 μm (1'')

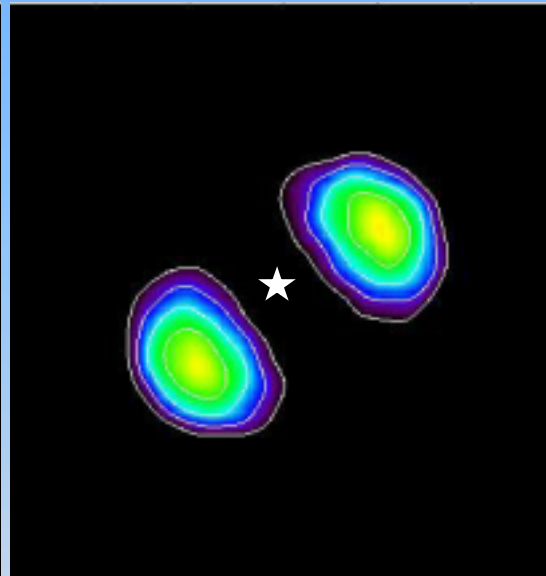

450 μm (9.5'')

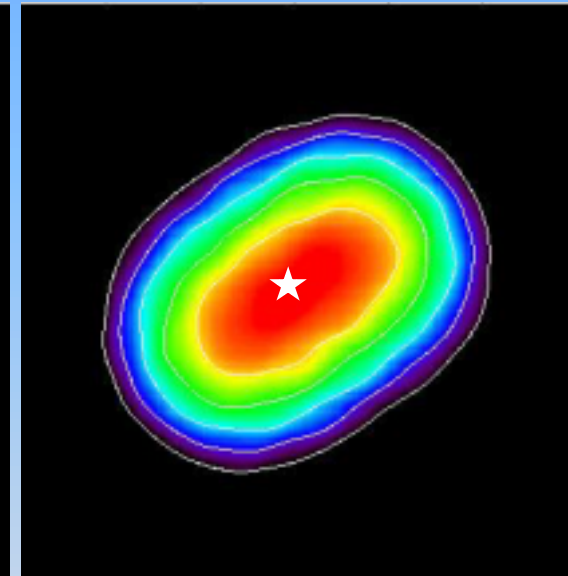

450 μm (13.7'')

The clumps in this model are caused by the migration of a Neptune mass planet from 80-105 AU over 25 Myr.

Conclusions

If there are planets in disks their resonances will affect the structure of the debris disks in a variety of ways:

- **gaps**
 - within asteroid belts
 - along orbit of planet
- **clumpy rings**
 - dust migration into resonance
 - resonance sweeping of planetesimals by planet migration
- Modelling the observed structures can be used to identify the presence of a planet and set constraints on its location, mass and even evolutionary history
- Multi-wavelength observations are particularly important for testing and constraining models