



*Innovative Measurement Electronics*



**PT Ltd.**

**PT252**

**PT253**

**Industrial  
Weighing Indicator**

Instruction Manual

Rev. 20161207

# CONTENTS

## Table of Contents

1 NOTICES.....	1	5.5 ANIMAL WEIGHING.....	18
1.1 SAFETY.....	1	5.6 TEMPORARY GROSS DISPLAY.....	18
1.2 PRECAUTIONS.....	1	5.7 UNIT CHANGE.....	19
2 DESCRIPTION.....	2	5.8 ADVANCED USER FUNCTIONS.....	19
2.1 INTRODUCTION.....	2	5.8.1 PLU memory.....	19
2.2 MODELS.....	2	5.8.2 ALU memory.....	19
2.3 FEATURES.....	2	5.8.3 CLU memory.....	19
2.4 STANDARD SUPPLIED ITEMS.....	3	5.8.4 Buzzer.....	19
2.5 DEFINITIONS.....	3	5.8.5 Backlight menu.....	20
3 SPECIFICATIONS.....	5	5.8.6 Auto power off.....	20
4 INSTALLATION.....	6	5.8.7 + Function Key Usage.....	21
4.1 GENERAL RULES.....	6	5.8.8 f Function Key Usage.....	21
4.2 CHANGING ORIENTATION.....	6	5.8.9 Stability filter.....	21
4.3 MECHANICAL INSTALLATION.....	6	5.8.10 Animal Filter.....	21
4.4 CONNECTING THE LOAD CELL.....	7	5.8.11 Tare Operation.....	21
4.5 RS-232C PORT CONNECTION.....	8	5.8.12 Serial Data Output.....	21
4.6 OPTIONAL 2 <sup>ND</sup> RS-232C PORT CONNECTION.....	8	5.8.13 Printer Settings.....	23
4.7 BATTERY INSTALLATION.....	9	5.8.14 Clock Menu.....	23
4.8 POWER SUPPLY AND GROUNDING.....	9	5.8.15 Test Menu.....	24
4.8.1 PT253 12VDC.....	10	6 SYSTEM CONFIGURATION AND SETUP.....	25
4.9 CHARGING THE BATTERY.....	10	6.1 ENTERING AND EXITING SETUP.....	26
4.10 CONFIGURING AND CALIBRATION.....	10	6.2 [BUILD] – OPERATIONAL PARAMETERS.....	26
4.11 CHECKING SCALE PERFORMANCE.....	10	6.2.1 [OIML] – Approved or industrial use.....	26
5 OPERATION.....	11	6.2.2 [InCr] - Increased display resolution.....	26
5.1 KEYPAD AND DISPLAY.....	11	6.2.3 [ZrnG] – Zero range.....	26
5.2 BASIC WEIGHING.....	12	6.2.4 [PZer] – Power On Zero range.....	27
5.2.1 Zeroing.....	12	6.2.5 [AZT] – Automatic Zero Tracking.....	27
5.2.2 Taring.....	13	6.2.6 [StbL] – Stability Delay.....	27
5.2.2.1 Multi-taring.....	13	6.2.7 [Motd] – Motion Detection.....	27
5.2.2.2 Tare/Clear.....	13	6.3 [CALIB] – SCALE BUILD AND CALIBRATION.....	27
5.2.2.3 Auto Tare.....	13	6.3.1 [Unit] – Units at power on.....	27
5.2.3 Gross/Net Function.....	13	6.3.2 [rAnG] – Single or Multi-range.....	27
5.2.4 Weight Accumulation.....	13	6.3.3 [P] – Decimal Point.....	27
5.2.5 Printing.....	14	6.3.4 [CAP] – Capacity.....	27
5.3 PIECE COUNTING.....	15	6.3.5 [d] – Division.....	27
5.3.1 Sampling.....	15	6.3.6 [CAL] – Calibration.....	27
5.3.2 Counting without a container.....	15	6.3.7 [LinCAL] – Linearity Correction.....	28
5.3.3 Counting pieces into a container.....	15	6.3.8 [ZERAdJ] – Zero Adjust.....	28
5.3.4 Counting pieces out of a container.....	15	6.3.9 FAST CAL.....	28
5.3.5 APW optimisation.....	16	6.4 [SYSTEM] – SYSTEM PARAMETERS.....	28
5.3.6 Piece count totalising.....	16	6.4.1 [GrAvit] – Gravity Compensation.....	29
5.3.7 Saving an APW value to memory.....	16	6.4.2 [OPER] – Operating Mode.....	29
5.3.8 Counting with a stored APW value.....	16	6.4.3 [dEF] – Defaults Reset.....	29
5.4 CHECK WEIGHING.....	16	6.4.4 [FAC] – Factory Reset.....	29
5.4.1 Saving check weighing targets in memory.....	17	7 TROUBLE SHOOTING.....	30
5.4.2 Weight Checking procedure.....	17	8 SECURING BY SEALING.....	31
5.4.3 Quantity Checking procedure.....	18	9 CONFORMITY.....	32

Always check the PT web site for the most up to date information and revisions  
[www.ptglobal.com](http://www.ptglobal.com)

# 1 NOTICES

## 1.1 SAFETY



**CAUTION!** READ THIS MANUAL BEFORE OPERATING OR SERVICING THIS EQUIPMENT. FOLLOW THESE INSTRUCTIONS CAREFULLY. SAVE THIS MANUAL FOR FUTURE REFERENCE. DO NOT ALLOW UNTRAINED PERSONNEL TO OPERATE, CLEAN, INSPECT, MAINTAIN, SERVICE, OR TAMPER WITH THIS EQUIPMENT. ALWAYS DISCONNECT THIS EQUIPMENT FROM THE POWER SOURCE BEFORE CLEANING OR PERFORMING MAINTENANCE. CALL PT LIMITED FOR PARTS, INFORMATION, AND SERVICE.



**WARNING!** ONLY PERMIT QUALIFIED PERSONNEL TO SERVICE THIS EQUIPMENT. EXERCISE CARE WHEN MAKING CHECKS, TESTS AND ADJUSTMENTS THAT MUST BE MADE WITH POWER ON. FAILING TO OBSERVE THESE PRECAUTIONS CAN RESULT IN BODILY HARM.



**WARNING!** FOR CONTINUED PROTECTION AGAINST SHOCK HAZARD CONNECT TO A PROPERLY GROUNDED OUTLET ONLY. DO NOT REMOVE THE GROUND PIN.



**WARNING!** DISCONNECT ALL POWER TO THIS UNIT BEFORE REMOVING ANY CONNECTION, OPENING THE ENCLOSURE OR SERVICING.



**WARNING!** BEFORE CONNECTING/DISCONNECTING ANY INTERNAL ELECTRONIC COMPONENTS OR INTERCONNECTING WIRING BETWEEN ELECTRONIC EQUIPMENT ALWAYS REMOVE POWER AND WAIT AT LEAST THIRTY (30) SECONDS BEFORE ANY CONNECTIONS OR DISCONNECTIONS ARE MADE. FAILURE TO OBSERVE THESE PRECAUTIONS COULD RESULT IN DAMAGE TO OR DESTRUCTION OF THE EQUIPMENT OR BODILY HARM.



**CAUTION!** OBSERVE PRECAUTIONS FOR HANDLING ELECTROSTATIC SENSITIVE DEVICES.

## 1.2 PRECAUTIONS

- Before using the instrument, check that the voltage indicated on the AC/DC adaptor label is the same as the local power supply. If it is not, do not connect the scale to the power supply, contact your instrument supplier.
- Before energising the instrument, check all connectors are installed properly and all external cables are installed safely to avoid mechanical damage.
- The scale should only be used under suitable environmental conditions as indicated in this manual.
- Do not use this scale in places where conditions are unstable or there is explosive danger.
- Do not place the scale near heat sources or under direct sunlight where it may heat up.
- Keep the scale as far away from other electromagnetic radiation sources as possible, their influence could affect the weighing accuracy.
- When the low-battery indication appears, the battery should be charged. If the battery remains discharged for a long period it deteriorates and could stop working. If the scale is not being used battery charging is recommended every month to ensure long battery life.
- Use only original BAT21 Li-ion batteries for your instrument safety.
- The battery must be removed before opening the housing otherwise the electronic circuit board will be damaged.
- Disconnect from the power supply and remove the internal battery located in the rear of the instrument and wait for 3 minutes before opening the instrument.
- Battery life is typically 300 cycles and should be replaced with an original "BAT21 Li-ion" battery, on expiry.

Failure to follow these precautions will void warranty, contact your supplier to clarify any questions.

### Rights and Liabilities

This publication may be reproduced in part, stored in a retrieval system, or transmitted in any form or by any means, mechanical, photocopying, recording, or otherwise, without the prior written permission of PT Limited.

No patent liability is assumed with respect to the use of the information contained herein. While every precaution has been taken in the preparation of this manual, PT assumes no responsibility for errors or omissions. Neither is any liability assumed for damages resulting from the use of the information contained herein.

The information herein is believed to be both accurate and reliable. PT, however, would be obliged to be informed if any errors occur. PT cannot accept any liability for direct or indirect damages resulting from the use of this manual.

PT reserves the right to revise this manual and alter its content without notification at any time.

Neither PT nor its affiliates shall be liable to the purchaser of this product or third parties for damages, losses, costs, or expenses incurred by purchaser or third parties as a result of: accident, misuse, or abuse of this product or unauthorized modifications, repairs, or alterations to this product, or failure to strictly comply with PT operating and maintenance instructions.

PT shall not be liable against any damages or problems arising from the use of any options or any consumable products in any way other than in accordance with their standard terms and conditions.

NOTE: The contents of this manual are subject to change without notice.

All rights reserved.

Copyright © 2015 by PT Limited, Auckland, New Zealand

## 2 DESCRIPTION

### 2.1 INTRODUCTION

The PT252 is a low cost, high quality general purpose weighing indicator for industry assembled in a plastic housing. The PT253 provides all the same features but is supplied in a more durable stainless steel housing. Weighing, Counting, Check Weighing and Dynamic Weighing for animals are standard as is printing selectable from 5 languages. It has 100 memory locations for Average Part Weight for counting and 100 product memories for check weighing.

Both indicators have UNDER, OK, OVER status bars and programmable buzzer for operator prompting during check weighing.

Operation is simple and practical via navigation keys with two programmable function keys and a 25mm high digits, wide viewing angle, backlit LCD display.

The PT252 is powered by an AC power adaptor and internal re-chargeable Li-ion long life battery while the PT253 has built in mains supply and can optionally be supplied with a 12VDC supply. A range of stand and wall mount accessories simplifies installation.

### 2.2 MODELS

<i>Model</i>	<i>Battery</i>	<i>Housing</i>	<i>Power</i>
PT252	Li-ion rechargeable	Plastic IP30	12 VDC (with 100–240 VAC adaptor)
PT253	Li-ion rechargeable	Stainless Steel IP65	100–240 VAC mains cable supply

\*\*Inquire with PT Sales regarding second RS-232 port or 12VDC supply for PT253.

### 2.3 FEATURES

- 40 x 112 mm liquid crystal display with 25mm digits and backlight.
- Multicolor LCD display backlighting for PT253.
- Navigation keypad for intuitive menu use.
- Weighing units programmable to g, kg, lb or oz.
- Unit change feature between metric and imperial units.
- Single range or Multi-range operation.
- Linearity correction.
- Remote weight indicator connectivity with PT remote displays.
- Check weighing function for Hi/OK/Low with visual and audible confirmation.
- High accuracy parts counting function.
- Memory for 100 product weights during check weighing.
- Memory for 100 amounts for checking quantity at piece counting.
- Memory for 100 products for parts counting.
- Accurate animal weighing with an advanced dynamic load weighing algorithm.
- Stored totals for accumulation during weighing and counting.
- Automatic power off function.
- Multi-language RS 232C data output for printer, PC or remote display connection.
- 12VDC with 100–240VAC, 50-60 Hz regulated power adaptor for PT252.
- 100–240 VAC, 50-60 Hz supply for the PT253 and 12 VDC option.
- Optional second RS-232C data output for PC and printer.
- 

\*\*Inquire with PT Sales regarding second RS-232 port or 12VDC supply for PT253.

## 2.4 STANDARD SUPPLIED ITEMS

The following are the items supplied as standard. Please check the contents of your package before installing and advise PT of any discrepancies.

	<b>Indicator</b>	<b>PT252</b>	<b>PT253</b>
	Power adaptor 100-240VAC, 50–60 Hz / 12VDC, 0.8A	Included	Only with 12V version
	Indicator Support Part 1 (mounts on the rear of the indicator)	Included	Not Required
	Indicator Support Part 2. For pole mounting. (To be assembled on to the Indicator support part 1)	Included	Included
	Indicator Support Part 3 for wall mounting (To be assembled on to the Indicator support part 2 for wall mounting)	Included	Included
	Battery, BAT21 Li-ion	Included	Installed
	1 pcs. Load cell connector	Included	Not required
	4 pcs. rubber foot used when desk mounted	Included	Not Required
	2 pcs. Side screw hole cover	Included	Not Required
	Sealing screws and cover	Included	Optional Extra
	3 pcs. M4 screw for installing Support part 1 to the indicator.	Included	Not Required
	2 pcs. Allen screw installing support 2 on to Support part 1.	Included	Included
	1 pc. Spacing tube.	Not required	Included
	Complete instruction manual	Included	Included

## 2.5 DEFINITIONS

### ADC:

Analogue to digital converter, converts the analogue signal into a digital signal.

### DAC:

Digital to analogue converter, converts the digital signal to an analogue signal, usually after some digital signal processing.

### Dead weight:

Dead weight is the self weight of the platform or scale load carrying structure on the load cells without

the contents or items to be weighed. The output voltage of the load cell in response to the weight of the platform is usually the zero offset. The zero offset must be within the range of the instrument adjustment for correct operation.

Live weight:

The weight that is applied to the scale and shown on the indicator.

Excitation voltage:

The voltage that is supplied by the indicator to the load cell.

Load cell:

Load cell is a device that converts force to electronic voltage. A load cell consists of two parts. The first part is a sensor that can be linearly distorted according to the force applied to it. The second part is the strain gauge element which changes its resistance according to the distortion of the sensor.

Load cell rated output:

The output voltage from the load cell divided by the excitation voltage at load cell rated capacity. This is usually expressed in mV/V.

Input range:

The maximum range of input that the device can accept. This is usually stated in mV and for a full load cell system is calculated from the number of load cells (LCn), mV/V (LCmv) and capacity (LCcap) and also the maximum total load (TL) (including dead load) on the load cells and the excitation voltage (EV).

$$\text{Input Range (mV)} = \text{TL} / (\text{LCn} * \text{LCcap}) * \text{LCmv} * \text{EV}$$

Note: A summing box with corner adjustment will reduce this value slightly.

FSO:

Full scale output. Errors may be presented as a % of the full output range after calibration.

PLU

Product Look Up. A code to look up values stored in product information

CLU

Counting Look Up. A code to look up values stored for counting

APW

Average product weight. Used in parts counting, this is the average weight of one piece of product, determined by weighing a sample and dividing by the number of parts.

ALU

Amount Look Up. A code to look up values stored in memory in relation to the amounts (quantity) of parts in check weighing.

Span Adjustment

Adjust the indicator so that when the load on the scale is changed the scale correctly shows the same change.



### 3 SPECIFICATIONS

A/D Converter		
A/D converter type	24 bit Delta-Sigma ratiometric with integral analog and digital filters	
Input sensitivity	0.4 $\mu\text{V/d}$ (approved); 0.1 $\mu\text{V/d}$ (non approved)	
Analog input range	0 mV to +18 mV (unipolar)	
Zero offset adjustment range	-18mV to +18mV	
Resolution		
Display resolution	up to 6 000 increments (approved); up to 3 0000 increments (industrial)	
Internal resolution	up to 16 000 000	
Scale Calibration and Functions		
Calibration	Calibration is performed with or without load cell non-linearity correction.	
Digital filter	3 steps programmable adaptive digital filter for normal weighing; 4 steps programmable filter for dynamic (animal) weighing.	
Weighing functions	Taring, zeroing, auto zero tracking, motion detection, auto zero at power up, increased resolution, unit change, temporary gross weight indication, dynamic(animal) weighing.	
Totalising	2 separate memories for Weighing and Counting.	
Counting	Sampling or using Average Part Weight (APW), APW optimization is available with APW memory for 100 different parts. Sampling quantity selectable as 10,20,30,50,100 pcs.	
Check Weighing (Classifying)	Under, OK, Over status bars on display and programmable buzzer, Memory for 100 products. Operator prompting with Under, OK, Over status bars on display and programmable internal buzzer	
Dynamic (Animal Weighing)	Supported by smart dynamic weighing algorithms.	
Memory locations	100 product memory for check weighing, 100 product memory for piece (parts) counting, 100 product sample quantity memory for piece (parts) counting.	
Load cells		
Excitation	5 VDC max. 100 mA	
Number of load cells	Up to 4 load cells 350 $\Omega$ , 8 load cells 700 $\Omega$ or 12 load cells 1100 $\Omega$ in parallel	
Load cell connection	4 or 6 wire technique. Cable length: maximum 2000 m/mm <sup>2</sup> for 6-wire connection	
Communication		
RS-232	1200 to 38400 baud rate, 8N1	
Second RS-232 (optional)	1200 to 38400 baud rate, 8N1. Transmit only.	
Data Output	Demand, Continuous and Fast Continuous	
Printing/Weigh Ticket		
Ticket Format	Programmable for different weighing modes. Format may include Date, Time, Ticket No, Gross, Tare and Net weights, Quantity. Label (print ticket) count number can be Preset.	
Date Format	Programmable as dd.mm.yyyy, mm.dd.yyyy or yyyy.mm.dd	
Print languages	English, Turkish, German, French, Spanish	
Power Connection		
	PT252 PT253	2000mAh Li-ion battery, up to 36 hours continuous operation for single load cell and 24 hours continuous operation for 4x350 Ohm load cells. Programmable auto power off.
	PT252	12 VDC with 100–240 VAC / 12 VDC adaptor
	PT253	100–240VAC, 50-60Hz built in. or 12VDC is configurable
Environment and Enclosure		
Operation temperature	-15 °C to +55 °C; 85% RH max, non-condensing	
Enclosure	PT252	ABS plastic, IP30. Size 220 x 110 x 55mm
	PT253	Stainless steel, IP65. Size 225 x 135 x 90mm

## 4 INSTALLATION

### 4.1 GENERAL RULES

*Warning: Please read this manual carefully before installing the instrument, especially the following before opening and servicing the instrument. Applying the recommendations in this section will increase your system reliability and long term performance.*

The following conditions should be met before servicing the instrument;

- The servicing shall be performed only by authorized technicians to prevent the instrument being damaged.
- The technicians body must be grounded by a grounding wristband or similar.
- A person who is not grounded must not touch the electronic board otherwise antistatic energy from the body might damage the electronic components.
- The environment shall be clean and the table shall have an anti-static top cover.
- The soldering machine should be grounded.

The following steps should be followed when opening the instrument:

- Disconnect the battery and the power adaptor before opening the instrument.
- Open the housing without touching the electronic board.
- Wait for 3 minutes if you will be disassembling the electronic board after disconnecting the battery and power adaptor.

When closing the instrument take care to ensure that the wires are neatly in position and not crushed or strained. To maintain the sealing of the PT253 ensure the seal is positioned correctly and the screws are tightened progressively to 0.4-0.5Nm (3.5-4.5 in-lb).

Follow the installation and commissioning steps described below carefully to prevent unwanted results after installation.

### 4.2 CHANGING ORIENTATION

The front part of the housing can be turned 180° so that the display can be mounted to a bench top scale base, taking care to note the above cautionary rules.

- Be sure the battery and AC/DC adaptor have been disconnected from the indicator for at least 3 minutes.
- Unscrew the 4 screws at corners. Open the housing and turn the front part of the housing carefully without touching the electronic board, adjust the battery connection as necessary.
- Close the housing and install the screws at the corners.

### 4.3 MECHANICAL INSTALLATION

The scale should be placed in as clean as possible an area, out of direct sun light if possible, with a temperature between -10 °C and +40 °C and humidity not exceeding 85% non-condensing.

The PT252 and PT253 instruments are very low level signal measuring instruments. To avoid electrical noise they should be separated from any equipment that produces electrical noise.

Make sure that the mechanical installation of the instruments is done properly to ensure the best life before starting the electrical installation as described below.

#### For desk or table top mounting of the indicator.

If the indicator will be used on a desk or table top, stick the 4 rubber feet on the back of the indicator (PT252 only). The PT253 does not require these for desk mounting.



#### For scale pole or wall mounting the indicator.

Install the **Support Part 1** bracket to the indicator with 3 pcs. M4 screws supplied in the box (PT252 only).



Install the **Support Part 2** on to the **Support Part 1** bracket (PT252 only) installed above as shown in the picture, after fitting the 2 Allen screws to it. **Support Part 2** can now be fitted over a round pole 38mm in diameter and locked in place with the Allen screws, or continue to the next step for mounting to a flat surface.



Install the **Support Part 2** on to the bracket that is a part of the PT253. Make sure the **Spacing Tube** is inserted over the locking screw and between the arms of the bracket. Install the Allen screws to **Support Part 2**, it can now be fitted over a round a pole 38mm in diameter and locked in place with the Allen screws, or continue to the next step for mounting to a flat surface.



If the indicator is to be mounted on a square column or to the wall, install the wall mounting **Support Part 3** part to the round column **Support Part 2** as indicated in the picture. Firmly mount the **Support Part 3** bracket to the wall or other flat surface supporting the indicator.

#### 4.4 CONNECTING THE LOAD CELL

Warning:

- Please always remember that the PT252 and PT253 indicators are very low voltage measuring instruments. Please do not forget that the instrument must be powered off before inserting or removing any peripheral connector.
- Good quality grounding of the instruments will improve weighing accuracy and the safety of your indicator. If the condition of your plant electrical supply fluctuates or is subject to noise and interference, prepare a special power line and grounding.
- All required electrical connections should be done as described below.

The electrical connectors of the PT252 are located at the bottom of the indicator as seen below left and electrical terminals of the PT253 are located on the printed circuit board inside the housing as seen below right. See 4.1 GENERAL RULES regarding accessing the PT253 housing.

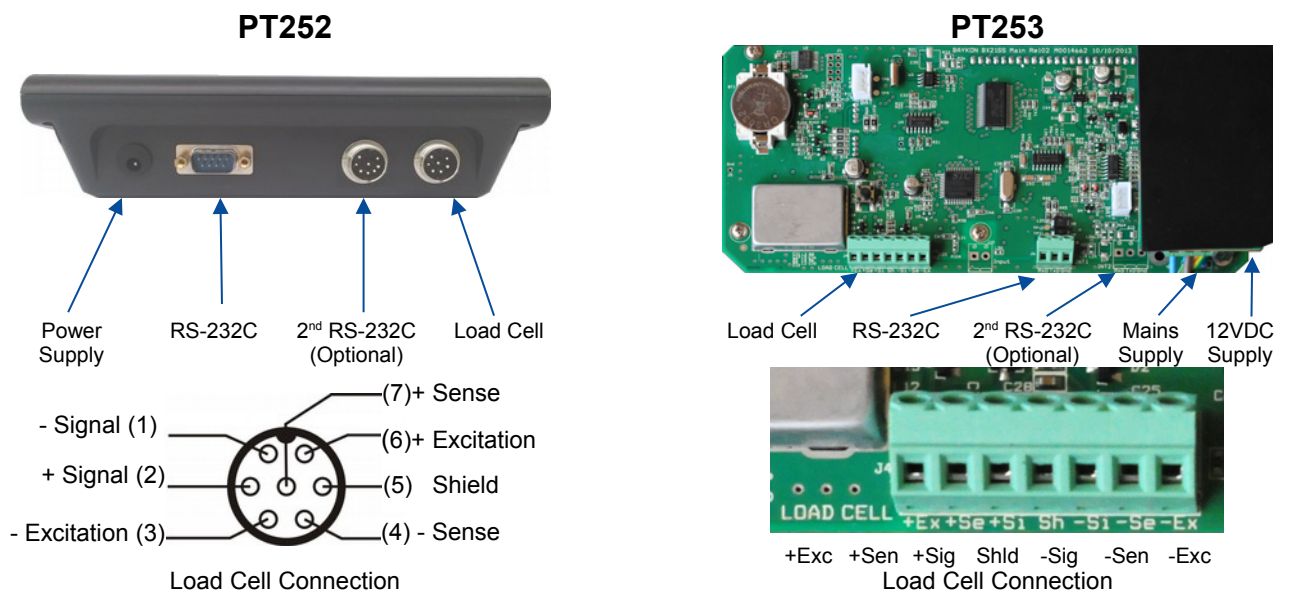

The load cell wiring should be installed carefully before energising to avoid damage to the instrument and load cells. The input resistance of the load cells that you want to connect should be more than 85Ω. Do not bind the load cell cables together with other cables as it could result in cross-talk interference. Please also keep them well away from the AC power cables.

Load cell connection details are shown above. In 4-wire installations the sense and excitation pins with the same polarity should be connected together in the connector (connect Sense+ to Excitation+, Sense- to Excitation-). If you have a junction box in your system, use 6 wire cable between the instrument and the junction box, and connect Sense and Excitation in the junction box for better performance.

The PT253 has sealing glands for the cables, these accept a round cable 4mm to 6.5mm diameter. Ensure the gland is tightened to grip and seal the cable.

*Warning: Always connect Sense pins to Excitation pins for 4 wire connection. Non-connected sense pins may cause the wrong Excitation voltage measurement and create an accuracy problem.*

*Warning: Connect the load cell cable shield to the reference ground or shield pin of the load cell connector.*

### 4.5 RS-232C PORT CONNECTION

RS 232C port usage and specifications are shown in the table below. Refer to 5.8.12 Serial Data Output of the manual to setup this interface.

Usage	Interfacing with a Printer, PC, PLC or remote display connection.
Data formats	You will find the data format details in 5.8.12.3
Baud rate	1200 / 2400 / 4800 / 9600 (Default) / 19200 / 38400 bps
Length and parity	8 bits no parity
Start / Stop bits	1 start bit and 1 stop bit

Table 1: RS-232C Serial Interface Specifications

The connection to the indicator RS-232 port is made as below. Connection to external equipment can be either 2 wire for transmitting data only to a printer, PC or remote display or 3 wire for conversational transmission where it is necessary to send the indicator commands or setup information.

The PT253 has sealing glands for the cables, these accept a round cable 4mm to 6.5mm diameter. Ensure the gland is tightened to grip and seal the cable.

	PT252	PT253
Definition	Pin number (DB9 Male)	Pin number (Terminal)
RXD	2	1
TXD	3	2
GND	5	3

Table 2: RS-232C connector

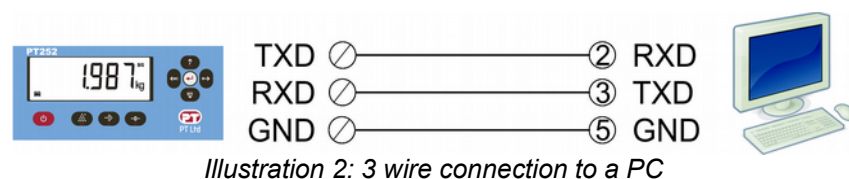
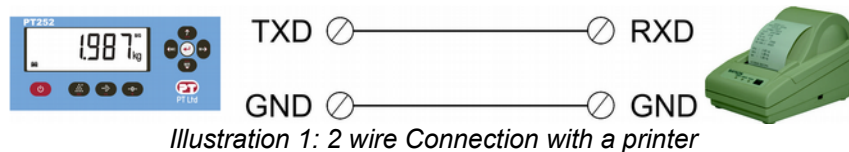

### 4.6 OPTIONAL 2<sup>ND</sup> RS-232C PORT CONNECTION

Optional RS-232C port usage and specifications are shown in the table below. Refer to 5.8.12.2 of the manual to setup this interface.

Note: This interface is transmit only.

Usage	Interfacing with a Printer, PC, PLC or remote display connection.
Data formats	You will find the data format details in 5.8.12.3
Baud rate	1200 / 2400 / 4800 / 9600 (Default) / 19200 / 38400 bps
Length and parity	8 bits no parity
Start / Stop bits	1 start bit and 1 stop bit

Table 3: 2<sup>nd</sup> RS-232C Serial Interface Specifications

	PT252	PT253
Definition	Pin number (Round Male)	Pin number (Terminal)
TXD	2	2
GND	3	3

Table 4: 2<sup>nd</sup> RS-232C connector

#### 4.7 BATTERY INSTALLATION

Due to transportation regulations the indicators are shipped without the batteries connected. The Li-ion battery should be connected after removing any insulation on the plug and if necessary installed into the instrument first as described below.

- Access the battery compartment of the indicator.
  - For the PT252 this is simply a matter of opening the battery cover.
  - For the PT253 the case must be opened by carefully removing the screws on the back. Take extra care not to damage the seal that resists dust and water entry. Disassemble the plastic battery holder.

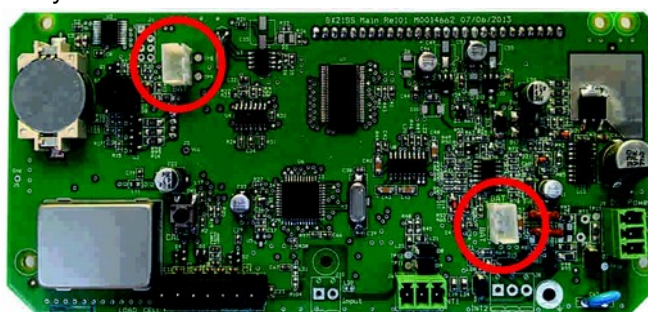

- Install the battery cable to the appropriate connector on the main PCB (there are 2 connection points circled) and fix the battery carefully into place. The location of the PCB battery connector for the PT252 can be seen through the battery housing. For the PT253 use the most convenient connector circled in the illustration above.
- Position the cable neatly inside the housing before replacing the battery cover or closing the case. Follow the information above in 4.1 GENERAL RULES especially in regards ensuring the PT253 is properly sealed.
- If the indicator turns on during connection of the battery, turn it off ready for the next stage.

#### 4.8 POWER SUPPLY AND GROUNDING

The weighing instruments measures very low signal levels. The quality of the mains power supply will affect the accuracy and the safety of your measuring system. It is very important that the instrument should not share power lines with noise-generating parts such as heavy load switching relays, motor control equipment, inductive loads, etc. If the condition of the mains power supply in the plant is poor, install a special mains power line and grounding.

The 12 VDC PT252 must be used with the regulated 12 VDC adaptor supplied with the instrument. Connect the AC/DC adaptor to the indicator before plugging the adaptor into the mains power supply. Before connecting the power supply, check that the voltage written on the AC/DC adaptor is the same as the local power supply. If it is not, do not connect the scale, and contact your authorised service representative. If the voltage is correct, connect the adaptor to the power supply. The arrangement of the 12V connection is shown below with the adaptor polarity on the right.



For the mains operated PT253 check that the voltage on the label matches the local power supply. If it does not, do not connect the scale, and contact your authorised service representative. If the voltage is correct, connect the adaptor to the power supply. A protected ground shall be connected to a 230 VAC powered instrument for safety and to protect against electrical disturbances.

#### 4.8.1 PT253 12VDC

To power the PT253 from 12VDC, remove the mains cable and replace it with a round cable of the same diameter with 3 wires that enables the cable gland in the case to seal properly. Connect the wires to the terminals indicated by the arrow in the image (see 4.4.) Ensure the earth connection is properly grounded. PT strongly recommends a 12V regulated power supply for best results, but the PT253 will function from a stable noise free power supply from 10.5 to 14.6VDC.

After the scale has been connected to the power, it performs a display test. When the display shows zero, the scale is ready for operation. The display may not show zero the very first time it is energised until configuration and calibration is complete.

#### 4.9 CHARGING THE BATTERY

Fully charging the battery before first using the instrument is recommended for long battery life. Do not disconnect the instrument from the power supply until at least 12 hours of charging is completed.

If you will not be using the instrument for a long period of time, recharging the battery every month is recommended.

#### 4.10 CONFIGURING AND CALIBRATION

Before using the scale it must be configured to display the correct capacity and increment and have a number of advanced functions configured in 6 SYSTEM CONFIGURATION AND SETUP. The scale must also be calibrated to display the weight correctly as detailed in 6.2 [BUILD] – OPERATIONAL PARAMETERS.

#### 4.11 CHECKING SCALE PERFORMANCE

*Warning:*

- *Scale set-up and calibration should be performed according to the needs of your application. Please read this document carefully and select the parameter values which will fit your application before programming the instrument.*
- *You cannot change Set-up parameter values and calibration after sealing the instrument in legal usage, be sure the proper adjustments have been done before sealing the scale.*

Check the scale performance by testing the scale eccentricity, scale linearity with loading up to the maximum loading value, repeatability, etc. before putting the scale into use.

## 5 OPERATION







Once you have familiarised yourself with the keypad and display you will find operation and set up quite straight forward.

### 5.1 KEYPAD AND DISPLAY

This small indicator has a large wide angle LCD display with backlight and ergonomically designed keys for easy operation. The weight display is displayed with up to 6 digits 25mm in height.



Keys and their functions for the PT252 and PT253 weighing indicators are below.

	<b>Power on/off key:</b> Press to turn the indicator on. To turn it off, press and hold the button for a few seconds.
	<b>+ key:</b> The most frequent used function key. Press to use the programmed function. (See 5.8.7 + Function Key Usage)
	<b>Sampling key:</b> Press and hold the key for a few seconds to start sampling in piece counting. (See 5.3.1 Sampling)
	<b>Escape key:</b> In menu mode, press this key to escape from menu and return to normal mode. Parameters are not saved.
	<b>Tare key:</b> Press this key to deduct the weight of the container placed on the platform so as to see the net weight value of the material subsequently added into or taken out of the container. (See 5.2.2 Taring)
	<b>Check weighing key(H-L):</b> To enter check weighing operation press this key until the [H-L : n] message appears. (See 5.4 CHECK WEIGHING)
	<b>Zero key:</b> This key adjusts the scale zero, if there is any residual weight or drift. Zeroing should be done without any load on the platform. (See 5.2.1 Zeroing)
	<b>f key:</b> During normal weighing press to use the programmed function. (See 5.8.8 f Function Key Usage)
	<b>ADV key:</b> This key is used to enter advance function setting by pressing and holding for a few seconds. (See 5.8 ADVANCED USER FUNCTIONS)
	<b>M+ Add to memory key:</b> Press this key to add the indicated weight to the accumulator in weighing and in counting operations. (See 5.2.4 Weight Accumulation in weighing and 5.3.6 Piece count totalising in piece counting)
	<b>MR Memory read:</b> Press this key to show accumulated total weight in weighing operation or accumulated quantity in piece counting operation. (See 5.2.4 Weight Accumulation in weighing and 5.3.6 Piece count totalising in piece counting)
	<b>MC Memory clear key:</b> Press this key to erase the accumulated value from memory. The weight and count accumulators will be erased separately. (See 5.2.4 Weight Accumulation in weighing and 5.3.6 Piece count totalising in piece counting)
	<b>Enter key:</b> Press this key for printout or to move to the next item during configuration.
	<b>Navigation keys:</b> Navigation keys are located on the right of the indicator front which are up, down, left and right arrow keys. These keys are used for navigation in set up and to change any numerical value. RIGHT: Next menu item, select digit to the right. LEFT: Previous menu item, select digit to the left. UP: Increase the selected digit value. DOWN: Decrease the selected digit value.



An explanation of the annunciators seen on the display is below.

	<b>Unstable:</b> This sign appears if the load on the scale is not stable. The weight value of the object should be read if the scale is stable. Taring, zeroing, printing and accumulation are not available when the scale is unstable.
	<b>Center of zero:</b> This sign appears if the weight is $\pm 0.25e$ of the center of the zero. (See 5.2 BASIC WEIGHING)
	<b>Weight unit:</b> The weighing unit is located on the right of the weighing display as kg, g, lb, and oz. (See 5.7 UNIT CHANGE)
	<b>Net weight:</b> This sign indicates that the weight value is the net weight. (See 5.2 BASIC WEIGHING)
	<b>Gross weight:</b> This sign indicates the displayed weight value is the gross weight.
	<b>Operating range:</b> Announces the range of operation when the scale is configured for multi-range weighing.
	<b>Piece counting mode:</b> The value on the display indicates the quantity. (See 5.3 PIECE COUNTING)
	<b>Total:</b> Indicates that the displayed value is the accumulation in the memory (See 5.2.4 Weight Accumulation in weighing and 5.3.6 Piece count totalising in piece counting)
	<b>APW:</b> Indicates the displayed value is the average piece weight. (See 5.3.7 Saving an APW value to memory)
	<b>Gross / Net:</b> Temporary indication of the gross weight. (See 5.6 TEMPORARY GROSS DISPLAY)
	<b>Battery charging level:</b> This sign indicates the battery charging level. A moving level indicates the battery is charging.
	<b>Battery is empty:</b> Announces the battery is discharged and should be charged at the first convenient time.

## 5.2 BASIC WEIGHING

Press the [On/Off] key to switch the scale on. The indicator activates the display in few seconds then the indicator firmware name and version are displayed before display testing. After the start up cycle, the weight value is displayed. [E E E] prompt at power on indicates the zeroing range at power on has been exceeded or the scale was not unloaded at power on. The scale should be unloaded before power on (7 TROUBLE SHOOTING).



Place the object you want to weigh on the scale. The weight of the object is shown on the display after the ~ symbol has gone out.

If you programmed one of the function keys (+ or f key) for unit changing, press this key to select the desired weighing unit (5.7 UNIT CHANGE) between metric and imperial units.

### 5.2.1 Zeroing

Zeroing is performed to compensate for deviations from zero of the unloaded scale. Sometimes there can be some small build up of material or drifting out of the automatic zero band.



- Clean the unloaded platform and check if there is anything touching the platform.
- Press the [ZERO] key to compensate for the zero deviation. Zeroing can be performed if the scale is stable and within the zero setting range.
- The >0< sign appears to indicate that zeroing is complete and the scale is at center of zero.
- If zeroing is has not succeeded, wait for the ~ sign disappear and press the [ZERO] key again.

### 5.2.2 Taring

Taring is performed to deduct the initial weight of a container and its contents and to just display the net weight added into the container or unloaded from the container. The PT252 and PT253 are programmable for 3 types of tare function: Multi-tare, Tare/Clear, Automatic tare.

*Warning: The tare value cannot exceed the maximum scale capacity. The maximum amount that can be weighed in NET mode is the difference between the tare weight and the maximum scale capacity. Capacity in Net = Maximum scale capacity – Tare weight.*

#### 5.2.2.1 Multi-taring

- Place the container on the platform and press the [TARE] key.
- The display value is zeroed and the **NET** (net weight) symbol appears.
- Place the material in to the container and read the net weight of the material you added.
  - Alternatively you can press [TARE] above after placing a container of material on to the scale. You can remove material from the container and the scale shows how much material has been taken out.
- The tare value is used until either a new tare is set by pressing the [TARE] key or it is cleared after unloading the scale or zeroing the scale.

#### 5.2.2.2 Tare/Clear

- Place the container on the platform and press the [TARE] key.
- The display is zeroed and the **NET** (net weight) symbol appears.
- Place the material into the container (or remove it as explained above) and read the net weight.
- Press the [TARE] key to clear the tare. Or press the [ZERO] key after unloading the scale.

#### 5.2.2.3 Auto Tare

This function allows taring automatically after loading the scale in gross mode without pressing the [TARE] key if the load is bigger than 20e (20 divisions). After unloading the scale, the indication goes back to the gross weight. To activate the auto tare function, refer to Advanced functions in 5.8 ADVANCED USER FUNCTIONS.

- Place the container on the platform.
- The scale activates the tare function automatically after stabilisation.
- Place the material inside the container (or remove it as explained above) for net weighing.
- After unloading the scale, the indicator changes back to indicate in gross mode.

### 5.2.3 Gross/Net Function

You can use the Gross/Net function at any time to temporarily switch the display between the net and gross weight, if you have already programmed one of the function keys as a [G/N] key. After the [G/N] key is pressed, the display shows the gross weight for a few seconds and then automatically goes back to the net weight indication.

### 5.2.4 Weight Accumulation

To accumulate the weighing values, put the object on the platform and when display shows the weight has stabilised (~ symbol is off), press the [M+] key to add the weight value to the total.



The accumulation is complete with display of the accumulation quantity (above left).

To see the total value, press the [MR] key and the display will indicate the accumulated value.

To print the accumulation, press the [ENTER] key when the accumulated total is on the display. To erase the accumulated total, press [MC] and the accumulated value will be reset to zero after your confirmation.

### 5.2.5 Printing

You can connect your indicator to a printer as indicated in Illustration 1:2 wire Connection with a printer and then set serial data output related parameters and printer parameters to select the printout ticket format from the table below.

Press the **[ENTER]** key to print the ticket after loading when the indication is stable.

*Note: The load on the scale must be greater than 20 divisions of weight or the indicator will not print.*

As you see in this table, the printouts contain different data depending on the operating mode as configured in 5.8.13 Printer Settings and serial port settings 5.8.12.1 (optionally 5.8.12.2). For 16 character printers, select a narrow printer format which has abbreviated data names.

Ticket	Basic Weighing	Animal Weighing	Piece Counting	Check Weighing
<b>Form 1</b>	Gross 4.205 kg	Dyn Gross 4.206 kg	Quantity 4205 pcs	Gross 0.030 kg OK
<b>Form 2</b>	Weighing number #000010 15-09-2012 01:04:03 Gross 4.771 kg Tare 1.675 kg Net 3.097 kg	Weighing number #000014 15-09-2012 01:08:57 Dyn Gross 4.771 kg Tare 1.675 kg Dyn Net 3.096 kg	Weighing number #000018 15-09-2012 01:14:39 Gross 4.770 kg Tare 1.675 kg Net 3.096 kg  Piece Weight 0.00100 kg Quantity 3096 pcs	Weighing number #000024 15-09-2012 01:24:06 Gross 1.705 kg Tare 1.675 kg Net 0.030 kg OK
<b>Form 3</b>	Weighing number #000011 15-09-2012 01:04:53 Gross 4.771 kg Net 3.097 kg	Weighing number #000015 15-09-2012 01:10:02 Dyn Gross 4.771 kg Dyn Net 3.096 kg	Weighing number #000020 15-09-2012 01:16:35 Gross 4.770 kg Net 3.095 kg  Piece Weight 0.00100 kg Quantity 3095 pcs	Weighing number #000026 15-09-2012 01:24:47 Gross 1.706 kg Net 0.031 kg OK
<b>Form 4</b>	Weighing number #000012 15-09-2012 01:05:58 Net 3.096 kg	Weighing number #000016 15-09-2012 01:10:54 Dyn Net 3.096 kg	Weighing number #000022 15-09-2012 01:17:15 Net 3.095 kg  Quantity 3095 pcs	Weighing number #000027 15-09-2012 01:25:33 Target weight 3.000 kg Actual net 0.031 kg Deviation - 2.969 kg

In a similar way you can print to a PC with a connection as shown in Illustration 1: 2 wire Connection with a printer p8.

### 5.3 PIECE COUNTING

The PT252 and PT253 indicators have a number of powerful features for parts (piece) counting by weight as described in this section. It is recommended that you assign the  $\text{▲}+ \text{▲}$  key for piece counting counting (5.8.7 + Function Key Usage).

Press the  $\text{▲}+ \text{▲}$  key to enter piece counting mode. The last used average piece weight (APW) value will be used for counting. If no APW has been stored the default APW is the increment of the scale at power on.

#### 5.3.1 Sampling

The scale counts the pieces on it by using the average piece weight (APW) of the item calculated from a sample. In sampling, the PT252 and PT253 weigh a certain number of the pieces total weight in very high resolution and divide it by the number of pieces (called the sampling quantity) to find the average piece weight (APW). Based on this calculated average piece weight, counting can then be carried out.

*NOTE: Sampling should be performed very carefully for correct counting.*

1. Empty the scale and press the [ZERO] key so that the  $\text{>0<}$  symbol is seen on the display.
2. Press the  $\text{▲}+ \text{▲}$  key for a few seconds until the sample quantity shows on the display ([ 10] or any other sample quantity), the counting annunciator  $\text{▲}$  will be flashing. This value is the quantity of pieces you need to place on the platform for sampling.

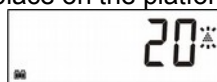

3. If pieces are small or piece weights are not very close to each other, sampling in higher quantity is recommended to increase the counting accuracy. To change the sampling quantity, press [▲] or [▼] to change the sampling quantity to 20, 30, 50 or 100 as required.
4. When exactly the quantity entered above is placed on the platform, press the [ENTER] key.
5. The display will stop flashing after sampling and the APW is calculated and start to display the quantity on the scale.

#### 5.3.2 Counting without a container

1. After sampling press the [ZERO] key so that the  $\text{>0<}$  symbol is seen on the display. Or recall the desired APW of the item from CLU memory (5.3.8 Counting with a stored APW value).
2. Place the pieces you want to count on the weighing pan.
3. The display will show the total quantity of pieces, the counting annunciator  $\text{▲}$  will be steady.

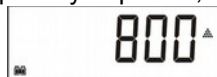

If you want to accumulate this count into the totalising memory, press the [M+] key (5.3.6).

To return to the weighing mode, press the  $\text{▲}+ \text{▲}$  key. The last used APW is retained and can be used the next time piece counting mode is entered.

#### 5.3.3 Counting pieces into a container

1. For counting into a container, place the empty container on the scale and tare with the [Tare] key. (After taring the scale the  $\text{>0<}$  sign should appear on the display).
2. If need be, you may perform sampling in the container after taring it to zero, to set the APW.
3. Add parts into the container to begin counting.

*Note: If the automatic taring function is active, you need not press the [Tare] key, because the scale will tare automatically as soon as the container is placed on the weighing pan.*

#### 5.3.4 Counting pieces out of a container

1. Place the full container on the weighing pan and then press the [Tare] key to tare the scale (the  $\text{>0<}$  sign should appear).
2. Press the  $\text{▲}+ \text{▲}$  key to go into piece counting mode.
3. If need be, perform sampling as in 5.3.1 Sampling or select the item APW from CLU memory (5.3.8 Counting with a stored APW value).
4. Take pieces out of the container as required, the display will show the quantity removed with a minus sign.
5. 6. Press [Tare] key to count a new quantity from the container.

Press the  $\text{▲}+ \text{▲}$  key to go back to basic weighing operation.

### 5.3.5 APW optimisation

Sampling in high quantity gives a more accurate result although the high quantity (such as counting out a sample of 100 pieces) is not as easy by hand. APW optimisation is strongly recommended for faster counting of higher quantities for a larger sample and more accurate piece counting. Follow the procedure below for APW optimization.

1. First count a small sample by hand, for example 10 pcs. and perform sampling (5.3.1).
2. Then count on the scale 20 pcs. and reapply sampling for 20 pcs.
3. Then count 50 pcs. on the scale reapply sampling with 50 pcs.
4. Then you can count 100 pcs. on the scale and reapply sampling with 100 pcs.

After each APW optimisation, piece counting accuracy will increase. The amount of optimisation required depends upon the variability of the piece weights.

### 5.3.6 Piece count totalising

You can accumulate the quantities of the parts counted and can view the total value in the piece counting accumulator (CAD).

1. For counting accumulation, press the **[M+]** key when the quantity is displayed and the display is stable (~ is not displaying). You will see the number of additions to the total on the display as **[Cad001]**, etc.
2. Place another batch on the scale for counting. After the quantity is displayed press **[M+]** key again to add the second counted quantity to total, **[Cad002]** will display. (2 quantities have been added to the total)
3. You can continue to add counted quantities to the accumulation memory by pressing the **[M+]** key.

The accumulated total count can be seen by pressing **[MR]** key.

The total count can be printed by pressing the **[ENTER]** key when the total count is displaying (after pressing the **[MR]** key).

To delete the accumulation, press the **[MC]** key when count accumulation is displaying (after pressing the **[MR]** key).

### 5.3.7 Saving an APW value to memory

Up to 100 average piece weights (APW) for different materials can be saved in CLU memory.

- To save an APW in to the CLU memory, press the **[ADV]** key in piece counting mode for a few seconds. The display shows **[CLU 01]**, with the 01 digits flashing.
- Change to the desired memory location (00 to 99) by pressing the **[▶]** and **[◀]** keys to shift to the digit to change and pressing the **[▲]** and **[▼]** keys to change the digit up or down.
- After accessing the desired memory location, press the **[ENTER]** key to save. The indicator goes back to the counting operation automatically.

### 5.3.8 Counting with a stored APW value

Counting can be performed with one of 100 APW values already stored to save re-sampling for different materials.

- To use a stored APW value press the **▲+▲** key for a few seconds to access setup in counting mode or in weighing mode to enter sampling.
- Press the **[▶]** key to show **[CLU 01]**, with the 01 digits flashing.
- Change to the desired memory location (00 to 99) by pressing the **[▶]** and **[◀]** keys to shift to the digit to change and pressing the **[▲]** and **[▼]** keys to change the digit up or down.
- After accessing the desired memory location, press the **[ENTER]** key to use the stored APW. The indicator goes back to the counting operation automatically.

## 5.4 CHECK WEIGHING

This function is used for classifying products as under, in tolerance and over weight. A Check weighing bar under the weight display helps the operator to see the deviation from target weight. The indicator is also programmable to provide an audible check weighing warning (5.8.4 Buzzer).

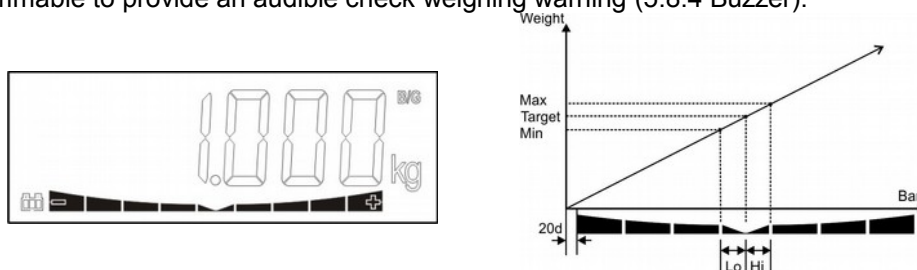

Check weighing operation first requires the nominal weight and tolerance values to be entered in to the PLU memory.

#### 5.4.1 Saving check weighing targets in memory.

*Warning: Entries into PLU memory must be done in the power on unit.*

The PT252 and PT253 indicators have 100 check weighing PLU memory locations for different materials and 100 ALU memory locations for checking quantity during piece counting. Data must be saved into the PLU / ALU memory locations before it can be used to classify the item on the scale as OK, under or over. Here the Target is the desired weight of the material. Hi and LO are the “+ tolerance” and “– tolerance” for the material respectively.

A weight or quantity between LO and HI is considered OK, outside this band it is over or under.

For example, if the target is 1000 g and the weight limits are 950g and 1100g during check weighing, enter values of Target = 1000g, Hi = 100g and Lo = 50g. The values for counting are entered into the ALU memory as number of pieces.

##### 5.4.1.1 Saving weight checking targets.

1. When in basic weighing mode enter the Advanced Functions menu by pressing the [ADV] key for a few seconds. The display shows [PLUPro].
2. Press [ESC] to exit or press [ENTER] to programme targets. When you press [ENTER] the display shows [PLU 01] with the 01 digits flashing.
3. Change to the desired memory location (00 to 99) by pressing the [▶] and [◀] keys to shift to the digit to change and pressing the [▲] and [▼] keys to change the digit up or down and press [ENTER], the display shows [tArGET].
4. Press [ENTER], the display shows the target weight. Change the value to the desired target weight by pressing the [▶] and [◀] keys to shift to the digit to change and pressing the [▲] and [▼] keys to change the digit up or down and press [ENTER], the display shows [HI].
5. Press [ESC] to exit to the menu at [PLUPro]. Press [ENTER], the display shows the target deviation for a high reading. Change the value to the allowable deviation above the target weight by pressing the [▶] and [◀] keys to shift to the digit to change and pressing the [▲] and [▼] keys to change the digit up or down and press [ENTER], the display shows [LO].
6. Press [ENTER], the display shows the target deviation for a low reading. Change the value to the allowable deviation below the target weight by pressing the [▶] and [◀] keys to shift to the digit to change and pressing the [▲] and [▼] keys to change the digit up or down and press [ENTER], the display shows [PLU 02] (the next memory location in sequence) with the digits flashing.
7. Continue entering more targets or press [ESC] twice to exit to normal operation.

##### 5.4.1.2 Saving count checking targets.

When in counting mode enter the Advanced Functions menu by pressing the [ADV] key for a few seconds. The display shows [ALUPro]. Follow the process in 5.4.1.1 above noting you will see ALU in place of PLU.

#### 5.4.2 Weight Checking procedure.

Check weighing is used for checking the weight of an item or material is within tolerance. This is indicated on the display with bars across the bottom and with an audible alarm if it has been programmed (5.8.4 Buzzer). On the PT253 the back light color changes automatically when check weighing to indicate the load is under, okay or over. Refer to 5.8.5.2 to adjust this feature.

1. Press the [H-L] key for a few seconds in basic weighing mode until the message below displays. The letter on the right indicates yes or no, if check weighing is enabled or not.

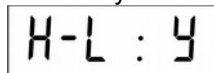

H-L : Y

2. To enable check weighing, press the [▲] key to select 'Y' and then press the [ENTER] key. Disable check weighing by selecting 'n'.
3. When 'Y' is selected, the PLU memory number shows on the display as [PLU :01].
4. Change to the desired memory location (00 to 99) by pressing the [▶] and [◀] keys to shift to the digit to change and pressing the [▲] and [▼] keys to change the digit up or down and press [ENTER] to start check weighing or press [ESC] to go to normal operation without saving.
5. The Target, Hi and LO values are displayed automatically after pressing [ENTER] before check weighing begins.



- Place the object or material on the platform and the check weighing bar will be activated by loading the platform as shown below. The buzzer and display will activate if enabled.



Under



In tolerance

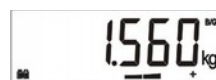

Over

- To return from the check weighing mode to basic weighing, press the [H-L] key for a few seconds, change the H-L value to "n" and press the [ENTER] key. The check weighing bar, buzzer and backlight will be disabled.

#### 5.4.3 Quantity Checking procedure.

This feature is used for checking whether or not the quantity is in tolerance during piece counting mode. On the PT353 the back light color changes automatically when counting to indicate the quantity is under, okay or over. Refer to 5.8.5.2 to adjust this feature.

- Press the [H-L] key for a few seconds in piece counting mode until the message below displays. The letter on the right indicates yes or no, if quantity checking is enabled or not.

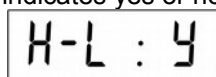

- To enable quantity checking, press the [▲] key to select 'Y' and then press the [ENTER] key. Disable quantity checking by selecting 'n'.
- When 'Y' is selected, the ALU memory number shows on the display as [ALU :01].
- Change to the desired memory location (00 to 99) by pressing the [▶] and [◀] keys to shift to the digit to change and pressing the [▲] and [▼] keys to change the digit up or down and press [ENTER] to start check weighing or press [ESC] to to normal operation.
- The Target, Hi and LO values are displayed automatically after pressing [ENTER] before quantity checking begins.
- Place the parts that require quantity checking on the platform and the quantity checking bar will be activated by loading the platform as shown below. The buzzer and display will activate if enabled.

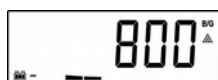

Under

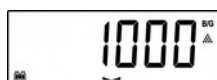

In tolerance

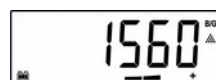

Over

- To return from the check weighing mode to basic weighing, press the [H-L] key for a few seconds, change the H-L value to "n" and press the [ENTER] key. The quantity checking bar, buzzer and backlight will be disabled.

## 5.5 ANIMAL WEIGHING

One of the function keys (the + key is recommended) has to be programmed for animal weighing before use, (5.8.7 + Function Key Usage). The indicator calculates the weight of the dynamic load after pressing the programmed function key. The dynamic filter value needs to be adjusted to suit your application for the best result. The dynamic weighing procedure is;

- Load the scale.
- Press the + key (or other key that has been programmed for animal weighing).
- The display shows [- - - -] to indicate that the PT252 or PT253 is measuring the dynamic weight.
- After calculating the dynamic weight, the indicator displays the value.
- Press the [ENTER] key to print out or the [M+] key to add the weight value to the totalising memory.
- Unload the scale or press the [ESC] key to go back to the basic weighing mode.

## 5.6 TEMPORARY GROSS DISPLAY

You may need to briefly view the gross weight value while in net weighing mode. If one of the function keys is programmed to the G/N function (5.8.7, 5.8.8), temporary gross weight value indication is available during net weighing.

- Press the [G/N] programmed function key while in net weighing mode.
- The indicator activates the **B/G** and **G/N** annunciators and indicates the gross weight value.



- The display automatically goes back to net weight indication after 5 seconds.





## 5.7 UNIT CHANGE

You may need to change the units displayed in your application while you are weighing. One of the function keys should be programmed to be the Unit Change function to use this feature (5.8.7,5.8.8). The changeable units are between kg and lb or between g and oz.

- When the indicator is powered on the units will be as in the “Power On Unit” setting (6.3.1).
- Press the function key assigned above to switch to the second unit and display the weight in those units.
- Press the function key again to switch back to the first units.

*Warning:*

*PLU memory and CLU memory data entries should be made in the power on unit.*

*The Unit Change feature is not available after sealing the instrument in legal usage.*

## 5.8 ADVANCED USER FUNCTIONS

Please refer to 5.1 KEYPAD AND DISPLAY for the keypad button functions.

- To access these functions if the display shows [E E E], press [ENTER] first (see 7).
- You can change the advanced user functions of the instrument by pressing the [ADV] key for a few seconds while in the weighing mode to enter the set-up menu.
- You can access menus by pressing the [▶] key to change to the next menu, press the [ENTER] key to access items in the selected menu or press the [ESC] key to return to the previous step.
- The general arrangement of the menus is shown below. The [bLight] item is only for the PT253.

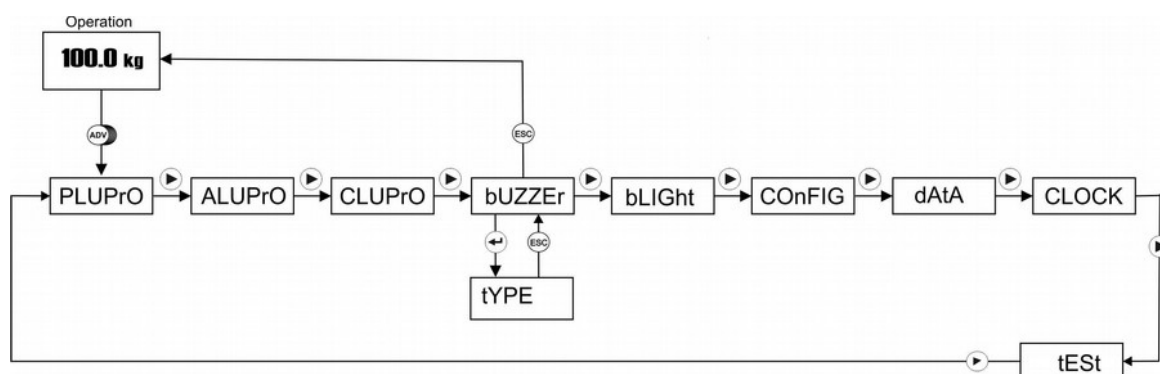

### 5.8.1 PLU memory

PLU memory is used in check weighing operations to store weight checking targets. This memory usage and data input are described in check weighing operation in 5.4.1.1 Saving weight checking targets.

### 5.8.2 ALU memory

ALU memory is used to check the quantity during piece counting to store quantity checking targets. This memory usage and data input are described in 5.4.1.2 Saving count checking targets.

### 5.8.3 CLU memory

CLU memory is used in piece counting operations to store average piece weights (APW). This memory usage and APW saving after sampling are described in 5.3.7 Saving an APW value to memory

### 5.8.4 Buzzer

To access the Buzzer related functions menu, press the [ADV] key for a few seconds until the [PLUPrO] message appears on the display. Press the [▶] key until the [bUZZEr] prompt appears and press the [ENTER] key so that [tYPE: ?] is displayed. ? Could be n, b or C.

#### 5.8.4.1 Buzzer Sound during Check Weighing

The buzzer sound can be programmed to be none, a continuous or a once only beep warning as shown in the table below. Use the [▲] key to change the value.

N = No sound,	b = One-time warning for 1 second	C = Continuous warning
---------------	-----------------------------------	------------------------

Press the [ENTER] key to proceed to the next item below, [ESC] to go back.

#### 5.8.4.2 Buzzer Mode during Check Weighing

The buzzer can set to activate in 3 different ways as follows, use the [▲] key to change the value. Press the [ENTER] key a number of times from the [bUZZEr] menu to access this item [MODe: ?].

Ou = Sound when weight is out of tolerance(Hi or Lo), in = Sound when weight is within the limits(OK), Hi = Sound when weight is over the high limit (Hi).
------------------------------------------------------------------------------------------------------------------------------------------------------------------

Press the [ENTER] key to proceed to the next item below, [ESC] to go back.

### 5.8.4.3 Keypad Sound

The buzzer can be set to beep when pressing keys as set below, use the [▲] key to change the value. Press the [ENTER] key 3 times in from the [bUZZER] menu to access this item [SOUUn:?].

N = No sound when keys are pressed,	Y = Sound when keys are pressed.
-------------------------------------	----------------------------------

Press the [ENTER] key to proceed to the next item below, [ESC] to go back.

### 5.8.5 Backlight menu

The backlight can be adjusted differently for the PT252 and PT253 and is found in the [CONFIG] and [bLiGht] menus respectively, each accessed as explained in 5.8 ADVANCED USER FUNCTIONS.

#### 5.8.5.1 PT252 backlight

To access the Backlight menu, press the [ADV] key for a few seconds until [PLUPRO] appears on the display. Press the [▶] key several times until the [CONFIG] prompt is seen. Press the [ENTER] key in this menu to display [LIGH:?], use the [▲] key to change the value of ?

OF = Backlight always off,	On = Backlight always on,
AU = Backlight is on during weighing and turns off after being idle for 5 seconds.	

Press the [ENTER] key to proceed to the next item in the [CONFIG] menu, [ESC] to go back.

#### 5.8.5.2 PT253 backlight

To access the Backlight menu, press the [ADV] key for a few seconds until [PLUPRO] appears on the display. Press the [▶] key several times until the [bLiGht] prompt is seen.

#### Backlight Activation

Press the [ENTER] key in this menu to display [LIGH:?], use the [▲] key to change the value of ?

OF = Backlight always off,	On = Backlight always on,
AU = Backlight is on during weighing and turns off after being idle for 5 seconds.	

Press the [ENTER] key to proceed to the next item below, [ESC] to go back.

#### Colour

The colour of the backlight can be changed.

When you press the [ENTER] key from above [CoLr:?] displays, use the [▲] key to change the value of ?

Wh = Backlight colour is white,	rE = Backlight colour is red,	Gr = Backlight colour is green,
bL = Backlight colour is blue,	YE = Backlight colour is yellow.	

Press the [ENTER] key to proceed to the next item below, [ESC] to go back.

#### H-L colour

The backlight can be programmed to change colour during check weighing for a positive visual confirmation.

When you press the [ENTER] key from above [H-L:?] displays, use the [▲] key to change the value of ?

?	<b>Under</b>	<b>OK</b>	<b>Over</b>
rE=	Red	Green	Yellow
YE=	Yellow	Green	Red

Press the [ENTER] key to proceed to the next item below, [ESC] to go back.

### 5.8.6 Auto power off

The indicator is programmable for automatic power off to increase the battery life if the scale is not used for a defined period. Press the [ENTER] key a number of times from the [CONFIG] menu to access this item [AOFF:?], use the [▲] key to change the value of ?

N = Disable,	1 = Automatic power off after 1 minute,
2 = Automatic power off after 2 minute,	3 = Automatic power off after 3 minute,
4 = Automatic power off after 4 minute,	5 = Automatic power off after 5 minute.

Press the [ENTER] key to proceed to the next item below, [ESC] to go back.

### 5.8.7 + Function Key Usage

The + function refers to the  key and can be programmed to provide direct access to various functions. Press the [ENTER] key a number of times from the [CONFIG] menu to access this item [-KEY:?], use the [▲] key to change the value of ?

N = Disable (no function assigned), Gn = Temporary Gross indication in Net,	PC = Piece count, Un = Unit change,	n = Increased resolution, An = Animal weighing.
--------------------------------------------------------------------------------	----------------------------------------	----------------------------------------------------

Press the [ENTER] key to proceed to the next item below, [ESC] to go back.

### 5.8.8 f Function Key Usage

The f function key refers to the top navigation key and can be programmed to provide direct access to various functions. Press the [ENTER] key a number of times from the [CONFIG] menu to access this item [FKEY:?], use the [▲] key to change the value of ?

N = Disable (no function assigned), Gn = Temporary Gross indication in Net,	PC = Piece count, Un = Unit change,	n = Increased resolution, An = Animal weighing.
--------------------------------------------------------------------------------	----------------------------------------	----------------------------------------------------

Press the [ENTER] key to proceed to the next item below, [ESC] to go back.

### 5.8.9 Stability filter

You can change the digital filtering with this parameter to compensate for the influence on the scale of vibration or motion in the environment or to increase performance or for faster response. Press the [ENTER] key a number of times from the [CONFIG] menu to access this item [FILt:?], use the [▲] key to change the value of ?

L = Faster response with low filtering, H = Slow response with high filtering.	M = Medium settling time (recommended).
-----------------------------------------------------------------------------------	-----------------------------------------

Press the [ENTER] key to proceed to the next item below, [ESC] to go back.

### 5.8.10 Animal Filter

This parameter changes the dynamic filtering to compensate for animal movement on the scale when in animal weighing mode. Higher filtering gives more reliable results for very dynamic loads. Press the [ENTER] key a number of times from the [CONFIG] menu to access this item [dYnA:?], use the [▲] key to change the value of ?

UL = Very low filtering (1.6 seconds), M = Medium filtering (4.8 seconds),	L = Low filtering (3.2 seconds), H = High filtering (6.4 seconds).
-------------------------------------------------------------------------------	-----------------------------------------------------------------------

Press the [ENTER] key to proceed to the next item below, [ESC] to go back.

### 5.8.11 Tare Operation

The PT252 and PT253 can have the tare function programmed to operate in 4 different modes with the tare key, including automatically, with this parameter as seen below. Press the [ENTER] key a number of times from the [CONFIG] menu to access this item [tArE:?], use the [▲] key to change the value of ?

N = Taring is disabled, tC = Set alternating Tare-Clear active,	Mt = Set Multi-tare mode active, AU = Set automatic taring active.
--------------------------------------------------------------------	-----------------------------------------------------------------------

Press the [ENTER] key to proceed to the next item below, [ESC] to go back.

### 5.8.12 Serial Data Output

To access the serial data output menu, press the [ADV] key for a few seconds until [PLUPrO] appears on the display. Press the [▶] key several times until the [dAtA] prompt is seen. Press [ENTER] to go into serial port 1 settings where [SPOrt1] is displayed or the [▶] key to access serial port 2 or printer menus.

*NOTE: Data is output with 8 data bits, no parity and 1 stop bit. Serial port 2 is an extra option.*

#### 5.8.12.1 Serial Port 1 Settings

Serial port 1 is included standard on the PT252 and PT253. To change Serial port-1 settings, press the [ENTER] key when the [SPOrt1] prompt is seen in the serial data output menu and [Form:?] will show.

#### Data Format

While the display is showing [Form:?] use the [▲] key to change the value of ? to set the data format.

*NOTE: Selct C1 for use with a remote display RD4, RD5 or RD6*

n = Data output is disabled, C2 = Continuous format 2 is selected 5.8.12.3.	C1 = Continuous format 1 is selected 5.8.12.3. Pr = Data output is formatted for a printer.
--------------------------------------------------------------------------------	------------------------------------------------------------------------------------------------

Press the [ENTER] key to proceed to the next item below [bAud:?], [ESC] to go back.

**Baud Rate**

While the display shows [bAud:?] use the [▲] key to change the value of ? to set the communication baud rate.

01 = 1200 baud,	02 = 2400 baud,	04 = 4800 baud,
09 = 9600 baud,	19 = 19200 baud,	38 = 38400 baud.

Press the [ENTER] key to proceed to the next item below, [ESC] to go back.

**5.8.12.2 Serial Port 2 Settings**

Serial port 2 is not standard and included as an option on the PT252 and PT253. To change Serial port-2 settings, press the [ENTER] key when the [SPort2] prompt is seen in the serial data output menu.

**Data Format**

While the display is showing [Form:?] use the [▲] key to change the value of ? to set the data format.

NOTE: Selct C1 for use with a remote display RD4, RD5 or RD6

n = Data output is disabled,	C1 = Continuous format 1 is selected 5.8.12.3.
C2 = Continuous format 2 is selected 5.8.12.3.	Pr = Data output is formatted for a printer.

Press the [ENTER] key to proceed to the next item below [bAud:?], [ESC] to go back.

**Baud Rate**

While the display shows [bAud:?] use the [▲] key to change the value of ? to set the communication baud rate.

01 = 1200 baud,	02 = 2400 baud,	04 = 4800 baud,
09 = 9600 baud,	19 = 19200 baud,	38 = 38400 baud.

Press the [ENTER] key to proceed to the next set up item 5.8.13 Printer Settings, [ESC] to go back.

**5.8.12.3 Continuous Data Formats**

Continuous data output from the instrument is transmitted in the following data structure.

**Continuous-1 Data Format**

The data format of the Continuous-1 data output is;

Status				Displayed Weight							Tare							
STX	STA	STB	STC	D5	D4	D3	D2	D1	D0	D5	D4	D3	D2	D1	D0	CR	LF	CHK

Following is the definition table for status bytes STA, STB and STC;

Definition Table for Status A (STA)								Definition Table for Status B (STB)							
Bits 0, 1 and 2			Bits 3 and 4			Bits 5,6	Bit 7	Bit 0	Bit 1	Bit 2	Bit 3	Bits 4,5	Bit 6	Bit 7	
0	1	2	Decimal point	3	4	Inc. size	Always 1	X	1 = Net	1 = Weight negative	1 = Error	1 = Unstable	Always = 1	1 = Zeroed with power on	X
1	0	0	XXXXXO	1	0	X 1			0 = Gross	0 = Weight positive	0 = No Error	0 = Stable		0 = Not zeroed with power on	
0	1	0	XXXXXX	0	1	X 2									
1	1	0	XXXXX.X	1	1	X 5									
0	0	1	XXXX.XX												
1	0	1	XXX.XXX												
0	1	1	XX.XXXX												

Status C (STC) is always hex '30'.

Note: The weight data is represented right aligned and the error messages (UNDER, OVER and A.OUT) are represented left aligned in the Displayed Weight field.

**Continuous-2 Data Format**

The data format of the Continuous-2 data output is;

[STX][STATUS][SIGN][DISPLAYED WEIGHT VALUE][UNIT][CR][LF][CHK]

Examples : (without control codes [STX], [CR], [LF] and [CHK])

S+000123.4kg (weight is stable and 123.4)  
 D+000123.4kg (weight is dynamic and 123.4)  
 + (Over load)  
 - (Under load)  
 O (ADC out of range error)

#### Checksum Calculation:

CHK (Checksum) = 0 – (STX + STATUS + ..... + LF)

### 5.8.13 Printer Settings

From the [**dAtA**] menu press the [**ENTER**] key and then the [**▶**] key several times until the [**Print**] prompt is seen. Press the [**ENTER**] key to enter print setup, the display will show [**Form:?**].

#### Form

The first item of printer settings is the printout format. Printer data output can be set to 1 of 4 different print formats. The printout format differs also with the operating mode as described in 5.2.5 Printing. Select the printout format by using the [**▲**] key to change the value of ? as below.

1 = Format 1, 2 = Format 2, 3 = Format 3, 4 = Format 4.

Press the [**ENTER**] key to proceed to the next item below [**LF:?**], [**ESC**] to go back.

#### Line Feed

To configure the length of your printout you can print additional line feeds to feed the paper or ticket to a specified length. Set the number of additional line feeds here. While the display shows [**LF:?**] by pressing the [**▶**] and [**◀**] keys to shift to the digit to change and pressing the [**▲**] and [**▼**] keys to change the digit up or down.

Press the [**ENTER**] key to proceed to the next item below [**LanG:?**], [**ESC**] to go back.

#### Language

Tickets from the display can be printed in 5 different languages. While the display shows [**LanG:?**] use the [**▲**] key to change the value of ? as below.

EN = English, DE = German, FR = French, SP = Spanish, TR = Turkish.

Press the [**ENTER**] key to proceed to the next item below [**Cn** ], [**ESC**] to go back.

#### Weighing Ticket Number

It is possible to reset the weighing ticket number to a value between 000001 and 999999 with this parameter. When [**Cn** ] is displayed press [**ENTER**] and use the [**▶**] and [**◀**] keys to shift to the digit to change and the [**▲**] and [**▼**] keys to change the digit up or down and press [**ENTER**] to save and move to the next item [**tYPE:?**].

#### Printer Type

The display printout type can be set for narrow (16 characters wide) or wide (26 or more characters wide) printers. While the display shows [**tYPE:?**] use the [**▲**] key to change the value of ? as below.

S = Printout for narrow printers, B = Printout for wide printers.

Press the [**ENTER**] key to proceed to the next item below [**CLoCk**], [**ESC**] to go back.

### 5.8.14 Clock Menu

To access the Clock menu, press the [**ADV**] key for a few seconds until the [**PLUPRO**] message appears on the display. Press the [**▶**] key several times until the [**CLoCk**] prompt is seen. Clock related items are located in this menu. Press the [**ENTER**] key to enter the [**CLoCk**] menu and the display shows [**Form:?**].

#### Date Format

While the display shows [**Form:?**] use the [**▲**] key to change the value of ? as below to set the date format.

D = DD:MM:YY M = MM:DD:YY Y = YY:MM:DD

Press the [**ENTER**] key to proceed to the next item below [**dAtE**], [**ESC**] to go back.

#### Date

While the display shows [**dAtE**], press the [**ENTER**] key to set the date. Use the [**▶**] and [**◀**] keys to shift to the digit to change and the [**▲**] and [**▼**] keys to change the digit up or down and press [**ENTER**] to save and move to the next item [**tIME**].

**Time**

While the display shows [tIME], press the [ENTER] key to set the time. Use the [▶] and [◀] keys to shift to the digit to change and the [▲] and [▼] keys to change the digit up or down and press [ENTER] to save and move to the next item [tEst].

**5.8.15 Test Menu**

The test menu is an aid the service technician for faster diagnosis of problems. To access the Clock menu, press the [ADV] key for a few seconds until the [PLUPrO] message appears on the display. Press the [▶] key several times until the [tEst] prompt is seen. When [tEst] displays press the [ENTER] key to display [iCoUnt] and then press the [ENTER] key to display the iCount value.

**iCount**

iCount is a value related to the ADC conversion value to help the service engineer to follow the scale performance in high resolution without dead load compensation.

Press the [ESC] key to return to the [tEst] menu. To go back to normal operation, press the [ESC] key a second time.



## 6 SYSTEM CONFIGURATION AND SETUP

Once you have familiarised yourself with the keypad and display you will find operation and set up quite straight forward. The instrument can be set up from the front panel keys and display prompts.

- If the display has been configured to operate in approved mode access to these menus is gained with the internal calibration switch rather than the front panel button.
- Setup menus consist of three main blocks which are build block, calibration block and system block.

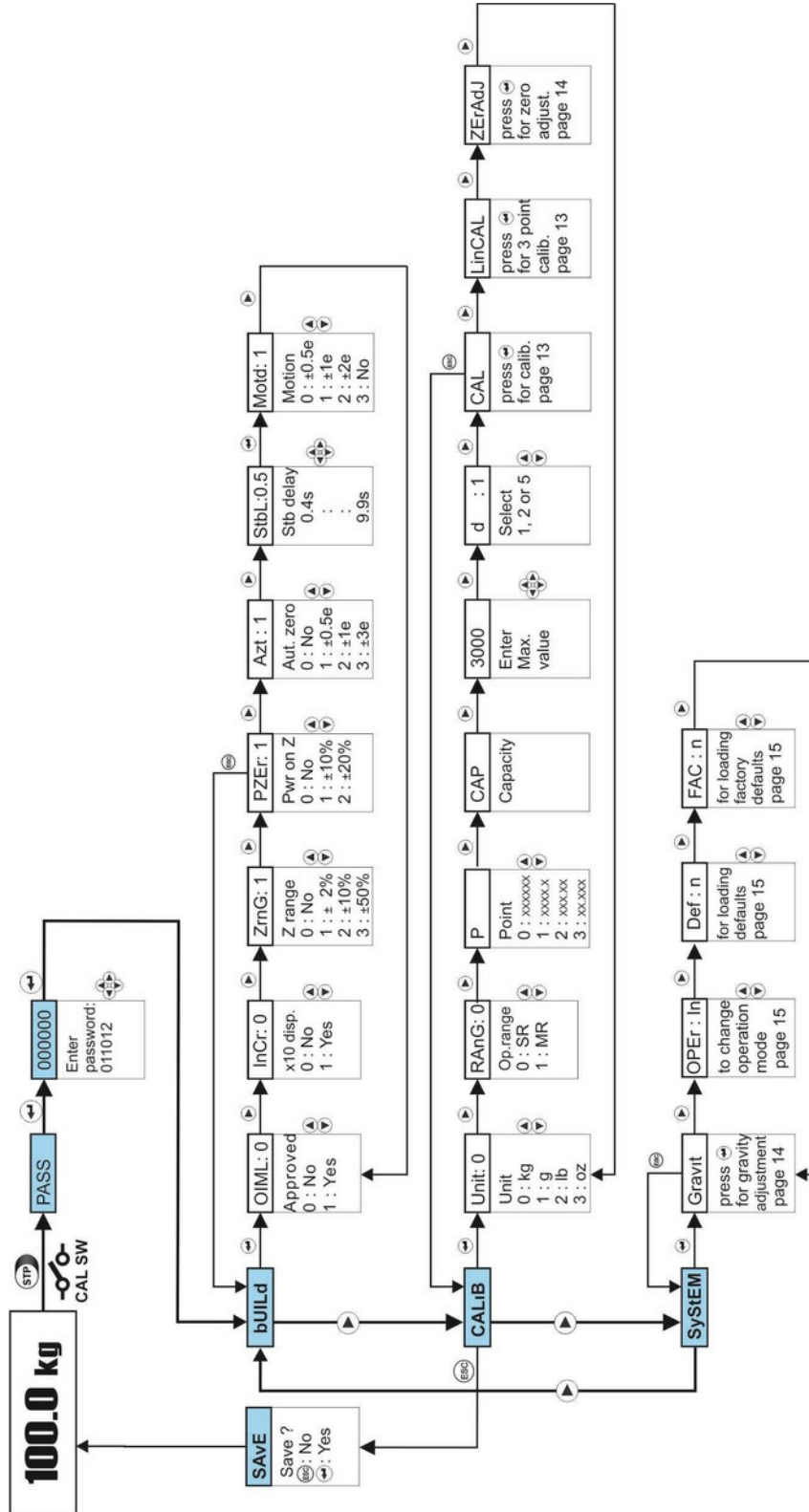

## 6.1 ENTERING AND EXITING SETUP

### Entering Setup

- To access these functions if the display shows [E E E], press [ENTER] first. See 7 TROUBLE SHOOTING to gain access to the menus.
- Access to setup is made from normal weighing mode.
- The displays can be configured to be in approved mode or industrial (non-approved) mode. In industrial mode system configuration is accessed by pressing the [STP] (SeTuP) key on the front panel for a few seconds.
- For the approved models there is an internal switch to gain setup access.

In the PT252 the internal setup switch is accessed through a hole on the rear of the instrument. The switch is a small button on the PCB through the hole and a little above the hole towards the threaded insert. Use a 3mm to 4mm diameter nonconducting (plastic) rod about 50mm long to press the switch through the hole. You will notice a click when the switch is depressed.



Press this switch for a few seconds to access setup. This switch is not accessible if the display is rotated (4.2), open the case for access.

The setup switch should be sealed before putting the scale in to use.

In the PT253 the internal switch is accessed by opening the casing to expose the main PCB (see 4.1). Use a 3mm to 4mm diameter nonconducting (plastic) rod to press the switch. You will notice a click when the switch is depressed.



Press this switch for a few seconds to access setup.

- When the setup switch or [STP] key has been pressed the display shows [PASS].
- Press [ENTER] and enter the pass code ('011012' by default) with the navigation keys by pressing the [▶] and [◀] keys to shift to the digit to change and pressing the [▲] and [▼] keys to change the digit up or down and press [ENTER] to confirm the pass code.
- If the pass code is correct you will reach the first setup block and the display will show [bUiLd]. Press the [▶] key to move to the other blocks [CALIB] or [SYSTEM].

### Exiting Setup

- To exit back to normal operation note the following;
  - If you are in a menu item press [ESC] to return to a main block ([bUiLd], [CALIB] or [SYSTEM]).
  - If you are in a block item press [ESC] to reach the [SAve] menu.
  - Press [ENTER] to save changes and return to weighing or [ESC] to return to weighing without saving changes.

## 6.2 [BUILD] – OPERATIONAL PARAMETERS

You set your scale parameters such as zero tracking and motion detection in this block. After entering setup (6.1) press [ENTER] to go into the menus of this block, press the [▶] and [◀] keys to move between menus and the [▲] and [▼] keys to change selections. Press [ENTER] to save a selection after changing it and to move to the next menu. Press [ESC] to exit a menu or return to a main block ([bUiLd], [CALIB] or [SYSTEM]).

### 6.2.1 [OIML] – Approved or industrial use

This parameter should be selected as '1' for approved scales and to activate the calibration switch to be able to secure the settings by sealing (8).

0 = Non-OIML scale applications,

1 = Approved scale applications.

### 6.2.2 [InCr] - Increased display resolution

This parameter allows the display resolution to be increased 10X. This is useful during mechanical setup, cornering and change point checking. Change back to 1X standard weight indication for normal operation.

0 = 1X Standard weight display,

1 = 10X Increased resolution.

### 6.2.3 [ZrnG] – Zero range

This parameter sets the range within which the instrument can be zeroed by pressing the [ZERO] key.

0 = Disable,

2 = ±10% of the scale range,

1 = ±2% of the scale range,

3 = ±50% of the scale range.

**6.2.4 [PZer] – Power On Zero range**

When the indicator is powered on it can automatically zero some weight on the scale. This parameter sets the range within which the instrument will be automatically be zeroed, it is measured from the zero set during calibration. When not disabled this function can conceal zero drifting from material build up or load cell damage.

0 = Disable,	1 = $\pm 10\%$ of the scale range,	2 = $\pm 20\%$ of the scale range.
--------------	------------------------------------	------------------------------------

**6.2.5 [AZT] – Automatic Zero Tracking**

This parameter sets the AZT to compensate small zero drifts from environmental effects like rain, snow and dust etc.

0 = Disable,	1 = $\pm 0.5 e$ ,	2 = $\pm 1 e$ ,	3 = $\pm 3 e$
--------------	-------------------	-----------------	---------------

**6.2.6 [StbL] – Stability Delay**

If the scale is stable for this period the scale is accepted as stable for the purposes of processing zeroing, tare, print, etc. functions. The delay can be set between 0.4 seconds and 9.9 seconds. Use the [▶] and [◀] keys to move between the digits and the [▲] and [▼] keys to change the digit value. Press [ENTER] to accept the value and move to the next step.

**6.2.7 [Motd] – Motion Detection**

This parameter controls the detection of motion and sets the range within which the scale will be considered stable. ~ will show on the display during weighing if the scale is not stable.

0 = $\pm 0.5 e$ ,	1 = $\pm 1 e$ ,	2 = $\pm 2 e$ ,	3 = Disable
-------------------	-----------------	-----------------	-------------

**6.3 [CALIB] – SCALE BUILD AND CALIBRATION**

You set your scale capacity and resolution and perform calibration in this block. Enter setup as per (6.1) (the display shows [bUiLd]) and press the [▶] key to move between the blocks ([bUiLd], [CALIB] or [SYStEM]) and press [ENTER] to go into the menus of this block, press the [▶] and [◀] keys to move between menus and the [▲] and [▼] keys to change selections. Press [ENTER] to save a selection after changing it and to move to the next menu. Press [ESC] to exit a menu or return to a main block ([bUiLd], [CALIB] or [SYStEM]).

**6.3.1 [Unit] – Units at power on**

Set the units that will display at power on and that must be used for setting PLU and APW values. You can use unit switching if enabled (5.7) to change the displayed units during weighing.

0 = kg,	1 = g,	2 = lb,	3 = oz
---------	--------	---------	--------

**6.3.2 [rAnG] – Single or Multi-range**

The PT252 and PT253 can function as single range or multi range scale indicators. Select the required range with this parameter.

0 = Single Range	1 = Multi-range
------------------	-----------------

**6.3.3 [P] – Decimal Point**

The decimal point position is set as below.

0 = XXXXXX,	1 = XXXXX.X,	2 = XXXX.XX,	3 = XXX.XXX,	4 = XX.XXXX,	5 = X.XXXXX
-------------	--------------	--------------	--------------	--------------	-------------

**6.3.4 [CAP] – Capacity**

A single range setup will show [CAP] and a multi-range setup will show [CAP1] and then [CAP2]. The maximum capacity is 15000kg or 30000lb. Press [ENTER] and use the [▶] and [◀] keys to move between the digits and the [▲] and [▼] keys to change the digit value. Press [ENTER] to accept the value and move to the next step.

**6.3.5 [d] – Division**

A single range setup will show [d] and a multi-range setup will show [d1] and then [d2]

1 = division of 1,	2 = division of 2,	5 = division of 5,	10 = division of 10.
--------------------	--------------------	--------------------	----------------------

**6.3.6 [CAL] – Calibration**

Calibration consists of two adjustments which are zero adjustment and span adjustment. The span can be adjusted with a single calibration load or with 2 calibration loads to provide linearisation and improve accuracy. If you will be performing linearisation during calibration, press the [▶] key to move to [LinCAL]. Calibration will only succeed if the scale is stable, if motion is detected it will fail. If calibration fails due to an unstable environment try adjusting the stability filter 5.8.9 temporarily during calibration.

For standard calibration continue as below.

1. Press **[ENTER]** to start the calibration.
2. At the **[UnLoAd]** prompt, unload the scale then press **[ENTER]**.
3. The indicator automatically starts to capture zero and the display shows [- - -] indicating the operation is in progress.
4. The **[LoAd]** prompt will show briefly and then the test weight value that will be used for the calibration is seen on the display as **[XXXXXX]**. If the value of the test weights that will be used is different from the value shown on the display, use the **[▶]** and **[◀]** keys to move between the digits and the **[▲]** and **[▼]** keys to change the digit value to the weight that you will be using. A minimum of 20% of the scale capacity set in 6.3.4 is necessary for calibration, 50 to 100% is recommended for better accuracy. A calibration error will result if insufficient weight is used.
5. Place the calibration weight on the scale.
6. Press **[ENTER]** to start span calibration and the display shows [- - -] indicating the operation is in progress. The scale must be stable to succeed.  
When finished the display continues to the next menu item **[LinCAL]** after completion.

### 6.3.7 [LinCAL] – Linearity Correction

Due to influences from the mechanical scale hardware, or load cell non linearity you may see non linearity of the scale performance. Three step calibrations will improve the scale performance.

If you will not be performing linearity correction press the **[▶]** key to continue

Linearity correction is performed as below.

1. Press **[ENTER]** to start three point calibration.
2. At the **[UnLoAd]** prompt, unload the scale then press **[ENTER]**.
3. The indicator automatically starts to capture zero and the display shows [- - -] indicating the operation is in progress.
4. The **[LoAd1]** prompt will show briefly and then the test weight value that will be used for the first load calibration is seen on the display as **[XXXXXX]**. If the value of the test weights that will be used is different from the value shown on the display, use the **[▶]** and **[◀]** keys to move between the digits and the **[▲]** and **[▼]** keys to change the digit value to the weight that you will be using. This load should be between 35% and 65% of the scale's capacity set in 6.3.4.
5. Place the first calibration weight on the scale.
6. Press **[ENTER]** to start span calibration and the display shows [- - -] indicating the operation is in progress.
7. The **[LoAd2]** prompt will show briefly and then the test weight value that will be used for the second load calibration is seen on the display as **[XXXXXX]**. If the value of the test weights that will be used is different from the value shown on the display, use the **[▶]** and **[◀]** keys to move between the digits and the **[▲]** and **[▼]** keys to change the digit value to the weight that you will be using. This load should be between 75% and 100% of the scale's capacity set in 6.3.4.
8. Place the second calibration weight on the scale.
9. Press **[ENTER]** to start stage 2 span calibration and the display shows [- - -] indicating the operation is in progress. The scale must be stable to succeed.

When finished the display continues to the next menu item **[LinCAL]** after completion.

### 6.3.8 [ZERAdJ] – Zero Adjust

This parameter is used for updating just the zero calibration of the scale without having to perform a complete load calibration to compensate for inaccurate weighing due to zero shifts.

Before performing this step consider if the cause of the zero shifts requires investigation because it could indicate material build up, moisture ingress, wiring problems or an overloaded or faulty load cell. Perform zero recalibration as below.

1. Press **[ENTER]** to start the zero adjustment.
2. At the **[UnLoAd]** prompt, unload the scale then press **[ENTER]**.
3. The indicator automatically starts to capture zero and the display shows [- - -] indicating the operation is in progress. The scale must be stable to succeed.

When finished the display continues to the next menu item.

### 6.3.9 FAST CAL

The instrument has fast access to calibration to save time when only recalibration is needed, follow the steps below for fast calibration.

- Enter setup as explained in 6.1 ENTERING AND EXITING SETUP .
- While **[bUiLd]** is showing, press and hold the **[ZERO]** key for more than 2 seconds. This will take you directly to 6.3.6 **[CAL]** – Calibration where you can follow the standard procedure.

## 6.4 [SYSTEM] – SYSTEM PARAMETERS

You configure various system parameters in this block. After entering setup (6.1) press the **[▶]** key to move between the blocks (**[bUiLd]**, **[CALIB]** or **[SYSTEM]**) and press **[ENTER]** to go into the menus of

this block, press the [▶] and [◀] keys to move between menus and the [▲] and [▼] keys to change selections. Press [ENTER] to save a selection after changing it and to move to the next menu. Press [ESC] to exit a menu or return to a main block ([bUilD], [CALIB] or [SYSTEM]).

#### 6.4.1 [GrAvit] – Gravity Compensation

The acceleration due to gravity (g) determines the force on the scale of the mass you are weighing. This value is not constant all around the world or even across a country so that a scale calibrated in your factory may not be accurate when it is installed in a different location. There are 2 values stored for gravity compensation, [CAL-Gr] for the gravity value at the location of calibration and [USAGE] for the gravity value at the location of operation.

- When the scale is calibrated, calibration and operation are one in the same location. [CAL-Gr] and [USAGE] are set to the same value, which is (g) for the location of calibration.
  - When the scale is sent to another location, change [USAGE] to the value of g for the location where the scale will be operated.
1. When the display shows [GrAvit], press [ENTER] and [CAL-Gr] displays.
  2. Press [ENTER] and change the value to the g for the location of calibration by using the [▶] and [◀] keys to move between the digits and the [▲] and [▼] keys to change the digit value.
  3. Press [ENTER] to save that value and move to [USAGE].
  4. Press [ENTER] and change the value to the g for the location the scale will be used by using the [▶] and [◀] keys to move between the digits and the [▲] and [▼] keys to change the digit value. Remember that during calibration this value is the same as [CAL-Gr].
  5. Press [ENTER] to save that value and move to the next menu item.

*Warning: Check the scale accuracy after gravity adjustment against wrong entry.*

#### 6.4.2 [OPER] – Operating Mode

This parameter determines operation of the instrument as a scale indicator or as a remote display. Be very careful with the use of this item. The PT252 and PT253 can be configured to act as just a remote display without any weighing functions.

If you are not changing mode, press the [▶] key to move to the next menu.

*Important note: Only the baud rate of the serial port can be programmed for remote display use. The data format of the remote display is continuous format C1 (5.8.12.3 Continuous Data Formats). The instrument will restart after changing operating mode.*

In = Scale Indicator,	rE = Remote Display.
-----------------------	----------------------

To change the instrument operating mode, press the [▲] key to change the parameter and then press the [ZERO] key. The instrument will restart after changing operating mode.

If you have changed the mode but wish to exit without the mode being activated, press the [ENTER] or [▶] key to go to the next menu.

#### 6.4.3 [dEF] – Defaults Reset

This parameter loads the instrument default parameter values except calibration. Be very careful with the use of this item. Press the [▶] key to go to the next item if you do not wish to load defaults.

n = no,	Y = Load parameter defaults.
---------	------------------------------

To load the parameter defaults, press the [▲] key to change the parameter to 'Y' and then press the [ZERO] key. The instrument will restart after the defaults are loaded.

If you have changed the mode but wish to exit without the mode being activated, press the [▲] key to change the parameter to 'n' and then press the [ENTER] key to go to the next menu.

#### 6.4.4 [FAC] – Factory Reset

*Very important: If you load the factory defaults, the instrument will clear all data in it, including PLU, ALU and CLU memories, scale set-up, calibration, etc. and reset itself to reload default factory settings.*

This parameter resets all the instrument parameter values. Be very careful with the use of this item. Press the [▶] key to go to the next item if you do not wish to reset all settings to factory defaults.

n = no,	Y = Load parameter defaults.
---------	------------------------------

To reset the parameter defaults, press the [▲] key to change the parameter to 'Y' and then press the [ZERO] key. The instrument will restart after the defaults are reset.

If you have changed the mode but wish to exit without the mode being activated, press the [▲] key to change the parameter to 'n' and then press the [ENTER] key to go to the next menu.



## 7 TROUBLE SHOOTING

The PT252 and PT253 indicators have been designed as very reliable and virtually error free instruments. However if an error occurs, do not attempt to repair the equipment before you understand what caused the error. Note the status of the front panel, and try to find the problem with the help of the table given below. Don't let unauthorised people interfere with the instrument.

[ <b>AdcOut</b> ] on the display	The input exceeds the operating range of the ADC (internal electronics). Call service to check the load cells, wiring and connections and calibration.
[ <b>Over</b> ] on the display	The load cell signal is higher than the calibrated maximum level but not outside the ADC range. Call service to check the load cells, wiring and connections and calibration.
[ <b>Under</b> ] on the display	The load cell signal is lower than the calibrated zero level but not outside the ADC range. Call service to check the load cells, wiring and connections and calibration.
[ <b>E E E</b> ] on the display	The scale cannot automatically zero at power on, the zero may be outside the zero range from the setup. Check the scale. The scale should be unloaded at power on. Alternatively check the wiring or check for a damaged or overloaded load cell in the event that the load cell zero is out of the expected range. The display will show this error if there are no load cells connected. You cannot gain access to the user or system configuration menus with this error until you press the [ENTER] key.
Zeroing cannot be performed with the zero button	The weight may be outside the zero range from the setup. Check the wiring and check for a damaged or overloaded load cell in the event that the load cell zero is out of the expected range. Recalibrate the scale if the load cell zero is acceptable.
Displaying the incorrect weight	There may be something touching or interfering with the scale, the load cell mountings may not be free to function correctly or the calibration may have drifted over a longer period of time. Check all the mechanical aspects then recalibrate the scale. Only authorised technicians can break and re-seal approved (sealed) scales.
The indicator is not working when charging.	Change the battery. If that fails contact your service agent or PT.
There is a build up of heat at the back of the housing during battery charging.	Change the battery. If the build up of heat continues discontinue charging and contact your service agent or PT
Err 02	ADC communication error. - Change PCB.
Err 34	The signal from the load cells is not increasing after loading the scale. -Check the load cell connection, it may be damaged or reversed. -Check the excitation and sense for correct voltage. -Check the load cell cable connection to the PCB in the instrument. -Check the installation mechanically to ensure correct loading of the load cells. -Change PCB.
Err 35	The load increase is smaller than expected. - Check the installation mechanically to ensure correct loading of the load cells and no object interferes with the application of load. - Check the load cell connection. - Increase the size of the calibration test weight. - Change the PCB, return to PT.
Err 37	The signal is unstable during calibration. Ensure the signal is stable. It may be necessary to temporarily change the stability filter settings (5.8.9) for calibration and change them back for weighing.
Err 70	Maximum scale capacity is more than 15000 kg or 30000 lbs. - Reduce the capacity of the scale.
Err xx (other errors)	- Disconnect the power adaptor and battery. - reconnect the battery and power adaptor in sequence - Switch the instrument on if it is off. - If there is any malfunction, the PCB may be faulty, call service.



## 8 SECURING BY SEALING

### Sealing of the PT252

Sealing with sticker:

Calibration  
switch sealing

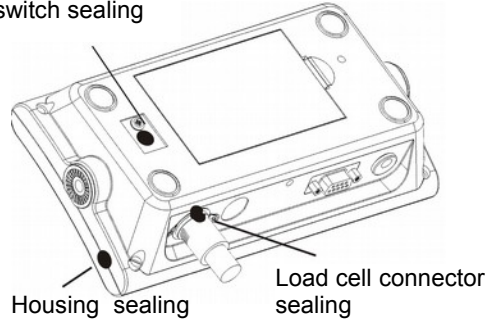

Sealing with a lead seal:

Calibration  
switch sealing

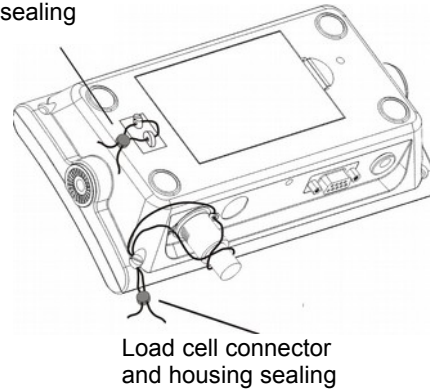

### Sealing of the PT253

*Note: The screws and cover required for sealing the PT253 are not supplied as standard and can be ordered as an optional extra.*

Sealing with a sticker:

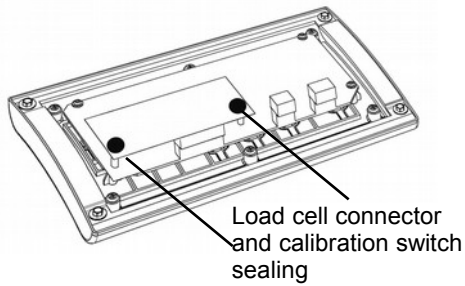

Sealing with a lead seal:

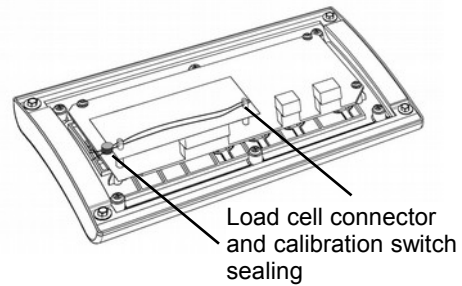

## 9 CONFORMITY

We;  
PT Limited

7 Marken Place, Auckland, New Zealand

Declare under our sole responsibility that the products; **PT252, PT253**,  
to which this declaration relates, are in conformity with the following standard(s) or other normative  
document(s).

EC Directive:	Applicable Standards:
Low Voltage Directive (LVD): (2006/95/EC)	EN 60950-1:2008
Electromagnetic Compatibility (EMC): (2004/108/EC)	EN 61326-1:2006

PT Limited, September 2015  
S M Edmonds

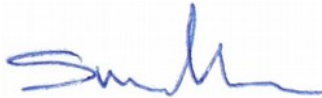

Technical Director