

# EPSON® PowerLite® 8100i/9100i Multimedia Projector



*User's Guide*

## Important Safety Information

**WARNING:** Never look into the projector lens when the lamp is turned on; the bright light can damage your eyes. Never let children look into the lens when it is on. Never open any cover on the projector, except the lamp and filter covers. Dangerous electrical voltages inside the projector can severely injure you. Except as specifically explained in this *User's Guide*, do not attempt to service this product yourself. Refer all servicing to qualified service personnel.

**WARNING:** The projector and its accessories come packaged in plastic bags. Keep plastic bags away from small children to avoid any risk of suffocation.

**Caution:** When you replace the lamp, never touch the new lamp with your bare hands; the invisible residue left by the oil on your hands may shorten the lamp life. Use a cloth or glove to handle the new lamp.

## Copyright Notice

All rights reserved. No part of this publication may be reproduced, stored in a retrieval system, or transmitted in any form or by any means, electronic, mechanical, photocopying, recording, or otherwise, without the prior written permission of SEIKO EPSON CORPORATION. The information contained herein is designed only for use with this EPSON product. EPSON is not responsible for any use of this information as applied to other products.

Neither SEIKO EPSON CORPORATION nor its affiliates shall be liable to the purchaser of this product or third parties for damages, losses, costs, or expenses incurred by purchaser or third parties as a result of: accident, misuse, or abuse of this product or unauthorized modifications, repairs, or alterations to this product, or (excluding the U.S.) failure to strictly comply with SEIKO EPSON CORPORATION's operating and maintenance instructions.

SEIKO EPSON CORPORATION shall not be liable for any damages or problems arising from the use of any options or any consumable products other than those designated as Original EPSON Products or EPSON Approved Products by SEIKO EPSON CORPORATION.

EPSON is a registered trademark of SEIKO EPSON CORPORATION.

EPSON PrivateLine is a service mark; EPSON Store and SizeWise are trademarks; and PowerLite and Presenters Club are registered trademarks of Epson America, Inc.

SRS and the  symbol are registered trademarks of SRS Labs, Inc., in the United States and selected foreign countries. SRS technology is incorporated under license from SRS Labs, Inc.

General Notice: Other product names used herein are for identification purposes only and may be trademarks of their respective owners. EPSON disclaims any and all rights in those marks.

# C

## *Contents*

### *Welcome*

Supported Computers and Video Sources .....	2
Getting More Information .....	2
Warranty and Registration .....	3
Controlling Your Projector from a Computer .....	4
Optional Accessories .....	4
About This Guide .....	6
Warnings, Cautions, and Notes .....	7
Reading This Manual Online .....	7

### **1** *Setting Up the Projector*

Unpacking the Projector .....	9
Additional Components .....	11
Installing Batteries in the Remote Control .....	12
Positioning the Projector .....	13
Choosing Your Connections .....	15
Connecting to a Computer .....	16
Connecting to a PC Desktop Computer .....	17
Connecting to a PC Laptop Computer .....	20
Connecting to a Desktop Macintosh .....	24
Connecting to a PowerBook .....	29
Making Other Computer Connections .....	33
Connecting to Other Video Sources .....	35
Connecting RCA Cables .....	36
Connecting S-Video or Component Video .....	37

## 2 *Using the Projector*

Turning On Your Equipment . . . . .	40
Turning On the Projector . . . . .	40
What To Do If You See a Blank Screen . . . . .	42
Sleep Mode . . . . .	43
Adjusting the Image . . . . .	44
Focusing and Zooming Your Image . . . . .	44
Resizing the Image . . . . .	45
Adjusting the Height of the Image . . . . .	46
Adjusting the Image Shape . . . . .	47
Adjusting the Tracking and Synchronization . . . . .	47
Using the Remote Control . . . . .	48
Using the Remote Control as a Wireless Mouse . . . . .	49
Zooming Your Image with the Remote . . . . .	50
Controlling the Projector . . . . .	51
Selecting Your Video Source . . . . .	51
Adjusting Sound Volume . . . . .	51
Stopping Action . . . . .	52
Turning Off the Picture and Sound . . . . .	52
Displaying Picture-in-Picture Video . . . . .	52
Drawing on the Screen . . . . .	53
Using the Cursor/Stamp Arrow . . . . .	54
Drawing Boxes . . . . .	54
Spotlighting Your Image . . . . .	55
Drawing Horizontal and Vertical Bars . . . . .	55
What To Do When the Lights Flash . . . . .	56
Using the On-Screen Help . . . . .	57
Shutting Down the Projector . . . . .	58

## 3 *Fine-tuning the Projector*

Using the Menus . . . . .	59
Changing Menu Settings . . . . .	60
Adjusting the Image . . . . .	63
Video Menu . . . . .	64
Saving and Recalling Computer Settings . . . . .	66
Adjusting the Sound . . . . .	67
Customizing the Drawing Tools . . . . .	68

Customizing Projector Features .....	69
Setting Menu .....	69
Advanced Menu .....	71
Creating a Screen Logo or Image .....	72
Capturing and Saving the Image .....	73
Assigning the Image to the No-Signal Message and/or A/V Mute Button .....	74
Viewing Projector Information .....	75
Restoring the Default Settings .....	76

## **4** *Maintaining and Transporting the Projector*

Cleaning the Lens .....	77
Cleaning the Projector Case .....	78
Cleaning and Replacing the Air Filter .....	78
Replacing the Lamp .....	80
Resetting the Lamp Timer .....	82
Transporting the Projector .....	82

## **5** *Solving Problems*

Problems with the Projector .....	84
Problems with the Remote Control .....	86
Problems with the Image or Sound .....	87
Where To Get Help .....	92
Telephone Support Services .....	92

## **6** *Technical Specifications*

General .....	93
Projection Lamp .....	94
Remote Control .....	94
Mouse Compatibility .....	94
Remote IR Receiver .....	94
Dimensions .....	94
Electrical .....	95
Environmental .....	95
Safety .....	95
Compatible Video Formats .....	95
Interface Connectors .....	98
Computer Video Port Pin Assignments .....	99
Image Size and Projection Distance .....	100

# 7 *Notices*

Important Safety Instructions .....	103
Remote Control Information .....	105
Declaration of Conformity .....	106
FCC Compliance Statement .....	107

## *Index*

# W

## *Welcome*

Your EPSON® PowerLite® projector is an ultra-bright, portable projector that lets you project brilliant, full-color images and video onto a large screen. Projected with up to 3200 or 2400 ANSI lumens, your presentations will be bright enough to be clearly seen with the room lights on.

Images are displayed in full color (16,770,000 colors) at a resolution of 1024 × 768 pixels (PowerLite 8100i) or 1280 × 1024 pixels (PowerLite 9100i). The projector supports a wide variety of video inputs, with resolutions up to 1600 × 1200. Built-in features include smooth motion technology, to produce the highest quality images, and digital noise reduction to reduce “color noise” and improve contrast.

You can connect the projector simultaneously to four image sources: one or two computers or workstation sources, plus two or three video sources, such as a VCR, DVD player, camcorder, digital camera, or laser disc player. You can also connect audio for up to three image sources.

The projector’s two speakers employ a built-in **●SRS** 3D sound system for rich, powerful audio output.

Your projector features a patented SizeWise™ chip for support of VGA, SVGA, XGA, SXGA, and UXGA output. No matter what type of computer output is used, the result is a full-size video image of outstanding clarity.

You can operate the projector from your computer or you can control it with a hand-held remote control unit. The buttons on the remote control allow you to turn the projector on and off, zoom in on your image, adjust the volume, mute the sound and image, switch from one computer or video source to another, and access the projector's built-in menus. If you connect the main cable and mouse cable, you can use the remote control as a wireless mouse; then you can continue your presentation as you move around the room.

## *Supported Computers and Video Sources*

The projector supports a wide range of computers and workstations: IBM® compatible PCs and laptops, Apple® Macintosh®, Power Macintosh™ series (including G3 and G4 systems), PowerBook® computers, iMac™ and iBook™ series, and workstations such as the Sun® SPARCstation.™ The video source can be HDTV, NTSC, PAL, or SECAM. The projector automatically senses the video format, which can be composite video, S-Video, or component video. See page 95 for details on supported computers and video formats.

## *Getting More Information*

Need tips on giving presentations? Quick steps for setting up your projector? Here's where you can look for help:

- **Online menu help**  
Extensive online help is available for operating the projector and using the projector's menus. You can display the help menu at any time by pressing the **Help** button on either the control panel or the remote control.
- **[www.presentersonline.com](http://www.presentersonline.com)**  
Includes a library of articles covering presentation tips, tricks, and technology. Provides templates, clip art and sound clips, as well as Presenters Services to use on the road. Even more resources and services are available if you register to join the Presenters Club®—and it's free.



- [support.epson.com](http://support.epson.com)  
Download FAQs and e-mail your questions to EPSON's technical support team.
- **Start Here** folder  
Contains your *Quick Setup* sheet, warranty brochure, CD-ROMs, and EPSON PrivateLine<sup>SM</sup> Support card. Store this *User's Guide* in the folder and keep the folder with your projector at all times.
- **Quick Setup** sheet  
Gives you all the instructions you need to get your projector set up and connected to a laptop or PowerBook computer.
- **CD-ROMs**  
The PowerLite 8100i/9100i CD-ROM lets you register electronically and includes the electronic version of this *User's Guide* plus a link to Presenters Online. On the Projector Software CD, you'll find the optional EMP Link V program and its *User's Guide*.

If you still need help after checking this *User's Guide* and the sources listed above, you can use the EPSON PrivateLine Support service to get help fast. Call (800) 637-7661 and enter the PIN on your card. Or take advantage of EPSON's automated support services 24 hours a day. See "Where To Get Help" on page 92 for more information.

---

## *Warranty and Registration*

Your projector comes with a basic carry-in warranty as well as an international warranty that let you project with confidence anywhere in the world. For details, see the warranty brochures included in your *Owner's Kit*.

To register, simply insert the PowerLite 8100i/9100i CD-ROM that came with your projector and select **Register Online**. Registering also lets you receive special updates on new accessories, products, and services. You can register through the Internet, by e-mail or 800-number modem connection, or by printing out the form to fax or mail.

## Controlling Your Projector from a Computer

### **note**

*The EMP Link V program is optional; you do not need to install it to use the projector.*

If you want to be able to control the projector's settings from your computer, you can install the EMP Link V program on the Projector Software CD-ROM. In addition to making the projector's features accessible from your computer, this program lets you enhance your presentations with special effects.

If you want to install EMP Link V, insert the Projector Software CD in your CD-ROM drive and follow the instructions on the screen. The installation program also installs the *EMP Link V User's Guide* on your hard disk. You can access this manual in the EMP Link V folder for complete instructions on using the program.

## Optional Accessories

To enhance your use of the projector, EPSON provides the following optional accessories:

Product	Product number
Customized carrying cases for the projector and its cables:	
Hard shell carrying case	ELPKS22
ATA shipping case	ELPKS21
Replacement lamp and air filter	ELPLP11
Short throw zoom lens	ELPLW01
Long throw zoom lens	ELPLL02
Extra long throw zoom lens	ELPLL03
Fixed short throw lens	ELPLR01
Ceiling mount	ELPMB31
Suspension adapter for ceiling mount	ELPMBAST
Kensington security lock	ELPSL01

<b>Product</b>	<b>Product number</b>
Portable projection screens 50-inch 60-inch 80-inch	ELPSC06 ELPSC07 ELPSC08
Remote IR receiver	ELPST04
Digital video cables: DVI to DVI, 10 feet (3 meters) DVI to DFP, 10 feet (3 meters)	ELPKC20 ELPKC21
Communication kit cable set and computer cable to connect projector to a second computer. There is also a Mac® adapter set so you can connect to a second Macintosh. You may also need the VGA-13W3 video cable (ELPKC06) if you're connecting the projector to a high-end workstation.  ELP communication cable set Computer video cable (HD15/H15, 1.8m) Computer video cable (HD15/HD15, 3.0m)	ELPKC04 ELPKC02  ELPKC09

You can purchase these accessories from your dealer or by calling EPSON at **(800) 873-7766**; or visit the EPSON Store™ at **www.epson.com** (U.S. sales only). In Canada, please call **(800) 873-7766** for dealer referral.

## *About This Guide*

---

This guide describes how to set up and use your EPSON PowerLite projector. The information applies to both the 8100i and the 9100i models. (Any differences are noted.)

Chapter 1, “Setting Up the Projector,” provides instructions on how to set up the projector and connect it to your computer, video source, or other optional equipment.

Chapter 2, “Using the Projector,” explains how to turn the projector on and off, adjust the image size and quality, use the remote control unit, control the audio and video, annotate your presentation with effects, monitor the projector’s operating status, and use the on-screen help.

Chapter 3, “Fine-tuning the Projector,” describes how to use the projector’s built-in menus to adjust the image settings, color, and sound; customize the drawing tools; create your own user logo or image; and view information about the projector.

Chapter 4, “Maintaining and Transporting the Projector,” covers basic procedures for maintaining your projector in good working order and gives guidelines for transporting it.

Chapter 5, “Solving Problems,” describes how to interpret your projector’s warning lights and gives helpful information for solving problems.

Chapter 6, “Technical Specifications,” lists the technical specifications for the projector.

Chapter 7, “Notices,” contains important safety instructions, technical information about the remote control, and the FCC compliance statement.

An Index is provided at the end of the manual.

## Warnings, Cautions, and Notes

Please follow these guidelines as you read this manual:

- Warnings must be followed carefully to avoid bodily injury.
- Cautions must be observed to avoid damage to your equipment.
- Notes contain important information about your projector.

---

**warning**

**caution**

**note**

---

## Reading This Manual Online

Your PowerLite 8100i/9100i CD-ROM includes an electronic copy of this manual. You may find it convenient to copy it onto your laptop's hard drive so it's always with you—for example, when taking your presentation on the road.

To read your electronic manual, you use Adobe® Acrobat® Reader. Just insert the PowerLite 8100i/9100i CD in your CD-ROM drive, select the **Install/View User's Guide** button and click **Install User's Guide** or **View User's Guide**.

---

**note**

*If you do not have Acrobat Reader, you can install it from the CD-ROM.*

---

When you open the manual, you'll see this toolbar:

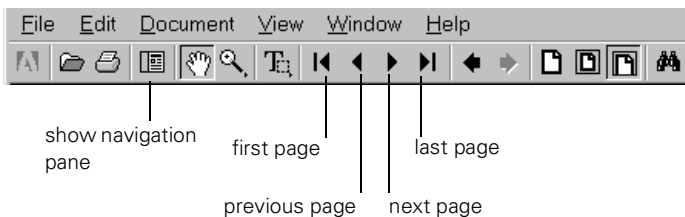

You have several ways to navigate through text:

- Click in the table of contents on the left side of the screen to move quickly to the topic of your choice.
- Use the arrow buttons in the toolbar or the vertical scroll bar on the right side of the document to move through a manual. (The box to the left of the scroll bar displays the current page number.)
- When your mouse pointer changes from a hand to a pointing finger, you can click to jump to a related topic.

For more information, see your Acrobat Reader online guide.



# 1 *Setting Up the Projector*

This chapter tells you how to unpack your projector and set it up for a presentation. The projector must be connected to a computer or a video source such as a VCR, DVD player, camcorder, digital camera, or laser disc player before it can project any images. You may also want to set up the projector for one or more of the following:

- Use the remote control as a wireless mouse. This lets you move around the room and interact with your audience, without worrying about where you'll stand.
- Provide audio for one or more of your image sources. The audio source can be the computer, video source, or another device such as a stereo.

## *Unpacking the Projector*

---

Make sure you have all the parts shown on the next page. (You won't need all these components; your configuration will determine which ones you need.)

Save all packaging in case you need to ship the projector. Always use the original packaging (or the equivalent) when you need to send the projector to another location.

If you're moving the projector by hand, use a carrying case (either a case available from EPSON or something similar, such as a laptop case). See page 82 for transportation instructions.

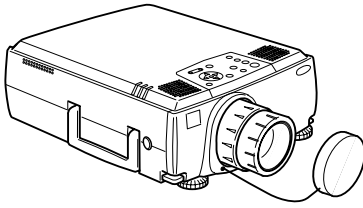

projector



remote control



EPSON PowerLite  
8100i/9100i CD-ROM



batteries

Projector software  
CD-ROM

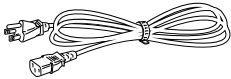

power cord

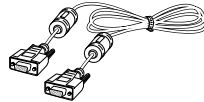

computer video cable

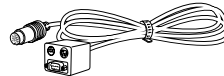

main cable



3.5-mm audio cable



RCA audio cable  
(red/white)



RCA video cable  
(yellow)

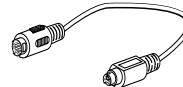

PS/2<sup>®</sup> mouse cable

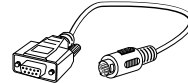

PC serial mouse cable

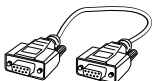

PC serial cable

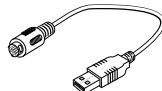

USB cable

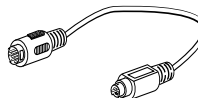

Mac mouse cable

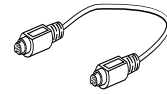

Mac serial cable

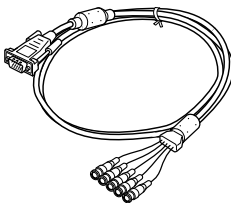

D-sub 15-pin to BNC cable

Macintosh adapter set

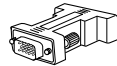

desktop adapter



monitor adapter



## ***Additional Components***

Depending on how you plan to use the projector, you may need additional components:

- To receive an S-Video signal, you need an S-Video cable. (One is usually provided with your video device.)
- To receive a component video signal from a VCR or other video device, you need a BNC cable (usually provided with the device).
- To take advantage of the projector's Digital Visual Interface (DVI), you need a DVI cable and your computer must be capable of producing video signals in DVI format. (See page 34.) You can purchase this cable from EPSON; see page 4.
- To connect the projector to a Macintosh PowerBook, you may need a video-out cable (provided by Apple). If your PowerBook requires a video-out cable and you do not have one, see your Macintosh dealer.

## **caution**

*When replacing batteries, take the following precautions:*

*Don't mix old and new batteries.*

*Replace batteries as soon as they run out. If the batteries leak, wipe away battery fluid with a soft cloth. If fluid gets on your hands, wash them immediately.*

*Remove batteries if you won't be using the projector for a long period of time.*

## *Installing Batteries in the Remote Control*

The remote control operates the projector and lets you access its Effects features. You can also run your presentation with the remote and use it as a wireless mouse.

Follow these steps to install the batteries:

1. Press the tab to release the battery compartment cover.

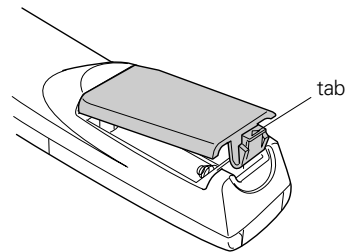

2. Remove the cover and insert the two AA batteries included with the projector as shown.
3. Replace the battery compartment cover.

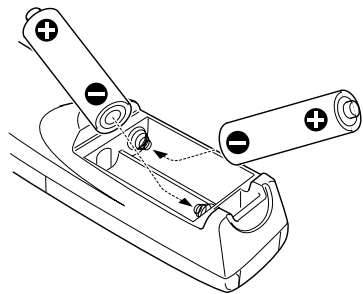

## Positioning the Projector

Before connecting the projector, you need to decide where to place it. The location you choose depends on the size of the audience (and room) and your presentation style.

- Place the projector on a sturdy, level surface, between 3 and 48 feet from the screen.
- Make sure there is plenty of space for ventilation around and under the projector.
- Make sure the projector is within 6 feet of a grounded electrical outlet or extension cord, and within 5 feet of your computer and/or video source.
- Face the projector squarely toward the screen. Otherwise, your image will be distorted.

Most presenters find it convenient to place the projector in the front of the audience, leaving as much space as possible between the screen and the projector. Then you can remain in front of the audience and close to the equipment.

Use the figure below as a guideline to help you determine how far from the screen to place the projector. The distances are based on using the standard lens. Your image size may not exactly match the sizes shown; its actual size depends on how you position the zoom ring and whether you have adjusted the image size with other settings (such as the keystone correction or **Resize** button).

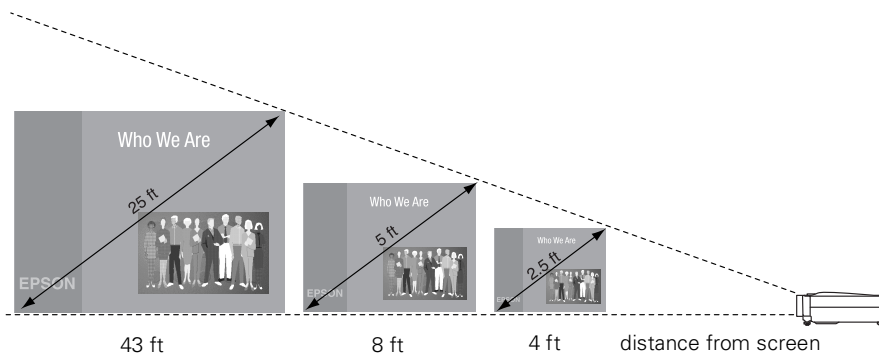

### caution

*Don't hold or lift the projector by the lens, or you may damage it.*

### note

*It's easier to position the projector when the screen is directly in front of the room. If the screen is placed diagonally in a corner, it's much more difficult to aim the projector squarely at the screen and get a non-distorted image.*

When projecting from a table, the ideal arrangement is to set the projector flat on its surface. This way, you can use the lens shift knob (instead of raising the projector's feet) to position the image on-screen. This delivers the best-looking picture.

You won't need to tilt the projector upward as long as you position it so that its lens is at least as high as the bottom of the screen, but no higher than the middle of the screen, as shown:

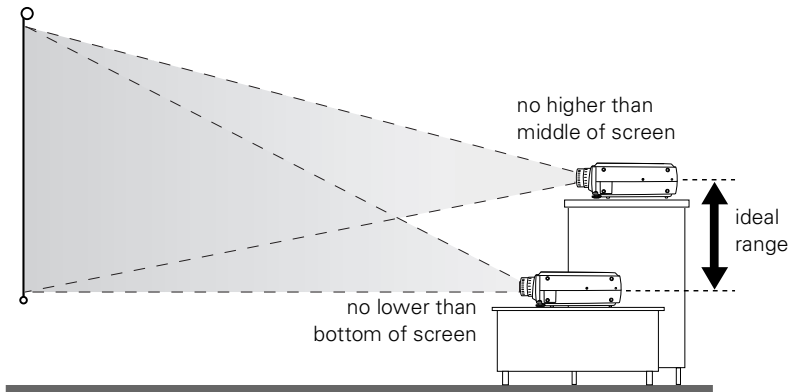

### **note**

*After positioning the projector, you may wish to connect a Kensington security lock to the hole on the projector's left side. This can be purchased from your computer or electronics dealer or from EPSON. (See page 4.)*

(If you have to raise the front of the projector, you can use the projector's keystone correction to eliminate distortion caused by tilting the projector upward. But you'll still get a better picture if you can leave the projector flat on the table, without extending its feet.)

If you'll be projecting from overhead, you can get the best-looking picture by mounting the projector parallel to the ceiling, with its lens at least as high as the middle of the screen, but no higher than the top of the screen. Then use the height adjustment knob to position the image on-screen. You'll also need to select ceiling projection in the projector's Advanced menu (see page 71).

## *Choosing Your Connections*

The connections you'll need to make depend on the equipment you're using, whether your presentation includes sound, and whether you plan to use the remote to run your presentation.

- **Connecting to a computer**

For many presentations, the only connection you'll need is between your computer and the projector. See "Connecting to a Computer" on page 16.

- **Connecting to other video sources**

You can connect a VCR, camcorder, laser disc player, DVD player, HDTV, digital camera, or any other video source to your projector. You can connect the video source and a computer at the same time, and easily switch between sources. See "Connecting to Other Video Sources" on page 35.

- **Using the remote control**

To use the remote control as a wireless mouse, you'll need to connect the mouse cable. When you use the remote, you can locate the projector (and computer) far enough from the screen to get a large image, without worrying about where you stand. This lets you move around the room and interact with your audience, while still controlling your presentation.

- **Including sound in your presentation**

If your presentation includes sound, you can connect an audio cable to use the projector's built-in stereo speakers. This is especially useful when the source of your presentation is a laptop.

## *Connecting to a Computer*

Follow the instructions below for the type of computer you need to connect:

- PC desktop computer on page 17
- PC laptop on page 20
- Macintosh desktop computer on page 24
- Macintosh PowerBook on page 29

The instructions in these sections explain how to connect your computer to the **Computer 1** port using the computer video cable. If you want to connect your computer using the BNC cable, or you want to connect a high-end workstation or a computer that outputs video in Digital Visual Interface (DVI) format, see “Making Other Computer Connections” on page 33.

After connecting your equipment, follow the instructions in Chapter 2 to turn on the projector and other components.

## Connecting to a PC Desktop Computer

To connect the projector to your PC desktop computer, you need to:

- Connect the computer video cable and computer monitor cable
- Connect the mouse and/or serial cable (if you want to use the remote control as a mouse or use the EMP Link V software)
- Connect the audio cable (if you'll be projecting with audio)

Follow the steps in each section for the cables you need to connect. Before beginning, turn off the projector and computer if they are on.

### Connecting the Video and Monitor Cables

This illustration shows the connections you'll be making. For details, follow the steps below.

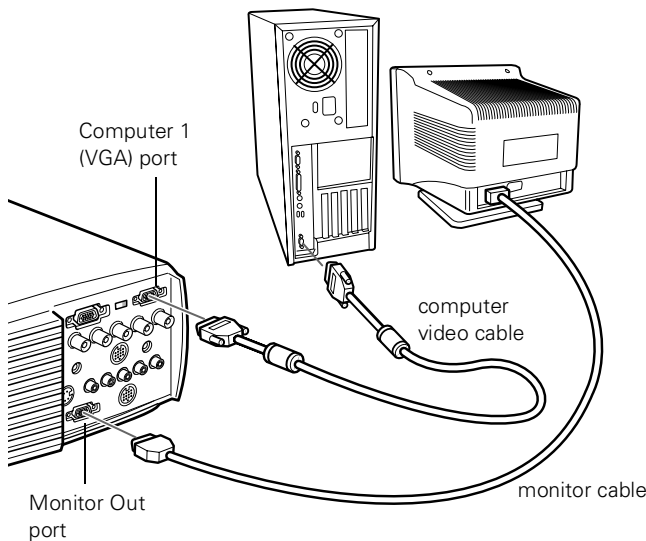

1. Disconnect the monitor cable from the video port on the back of your computer.
2. If you'll be viewing the video on your computer monitor as well as the projector screen, connect the monitor cable to the projector's **Monitor Out** port, as shown. (This is useful when you need to view the video output but the projection screen is behind you.)

### **note**

*Computer configurations vary. See your computer manual for the location of the ports needed to connect your projector.*

3. Connect one end of the computer video cable to the projector's **Computer 1 (VGA)** port.
4. Make sure the DVI/VGA switch on the back panel is flipped to the right, as shown. If necessary, use the tip of a ballpoint pen to slide it over.
5. Connect the other end of the computer video cable to the computer's video port.
6. Tighten the screws on the connectors.

DVI/VGA switch (slide to right)

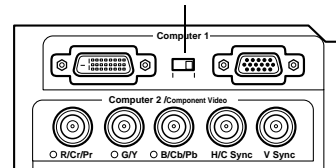

### *Connecting the Mouse and Serial Cables*

To use the remote control as a mouse or use the EMP Link V software, follow the steps below. This illustration shows the connections you'll be making:

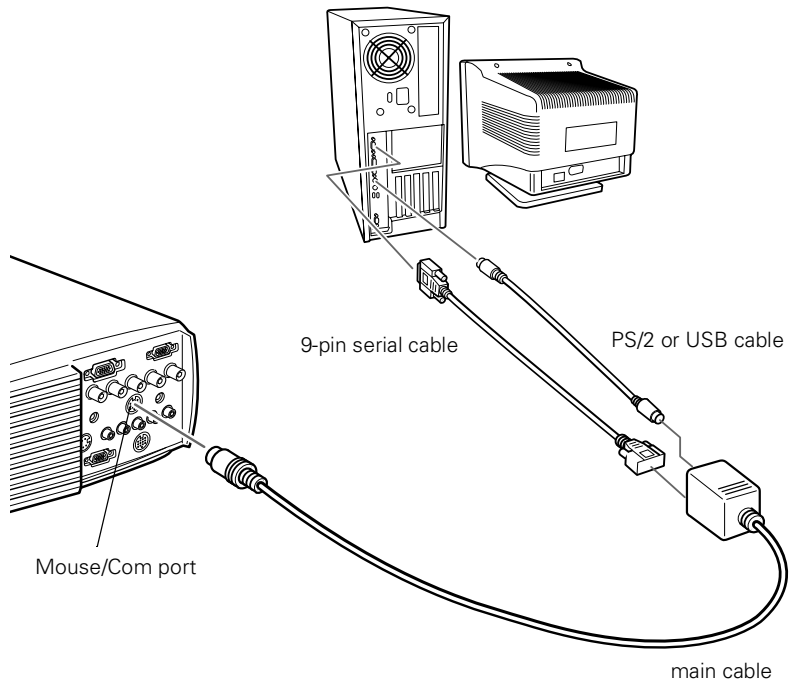

1. Connect the round end of the main cable to the projector's **Mouse/Com port**, as shown.



- To use the remote control as a wireless mouse, connect the PS/2 mouse or USB cable included with the projector to the **MOUSE** terminal on the square end of the main cable.

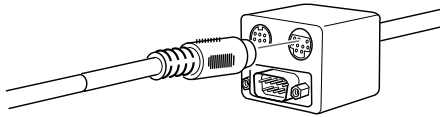

- Disconnect your mouse from the mouse port on the back of your computer and replace it with the other end of the PS/2 mouse or USB cable. (Your computer's mouse will be disabled while you are using the remote control as a mouse.)
- To use the EMP Link V software or to program new effects for the Effects buttons on the remote control, connect one end of the serial cable to the **SERIAL** terminal on the main cable.

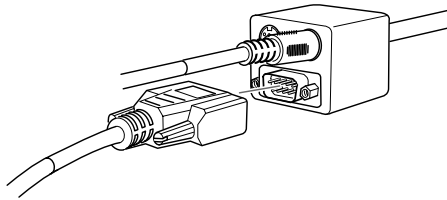

Connect the other end of the serial cable to the serial port on the back of your computer.

- Tighten the screws on the connectors.

---

**note**

*If your system uses a serial mouse, perform steps 2 and 3 using the PC serial mouse cable instead of the PS/2 mouse or USB cable.*

---

---

**note**

*You won't be able to use EMP Link V if your computer has only one serial port that is being used to support a serial mouse.*

---

## Connecting the Audio Cable

1. If you'll be using audio, connect one end of the 3.5-mm audio cable to the **Audio** port on the projector.

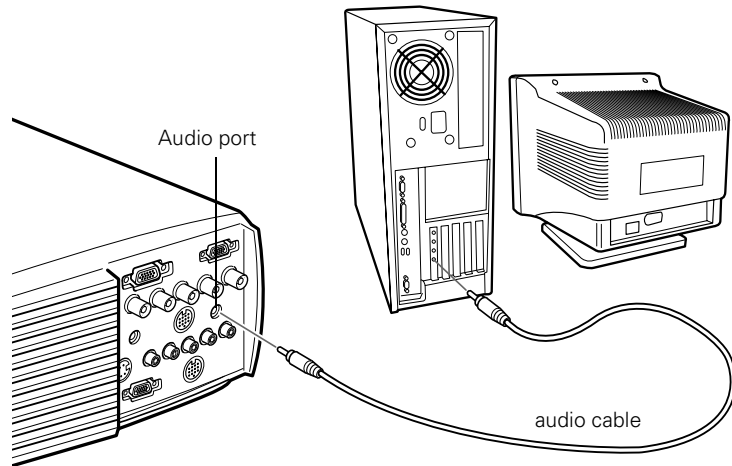

2. Connect the other end of the audio cable to the speaker or audio out port on the computer's sound card.

## Connecting to a PC Laptop Computer

To connect the projector to your PC laptop computer, you need to:

- Connect the computer video cable
- Connect the mouse and/or serial cable (if you want to use the remote control as a mouse or use the EMP Link V software)
- Connect the audio cable (if you'll be projecting with audio)

Follow the steps in each section for the cables you need to connect. Before beginning, turn off the projector and computer if they are on.

### **note**

*Laptop configurations vary. See your computer manual for the location of the ports needed to connect your projector.*

## Connecting the Video Cable

1. Connect one end of the computer video cable to the projector's Computer 1 (VGA) port.

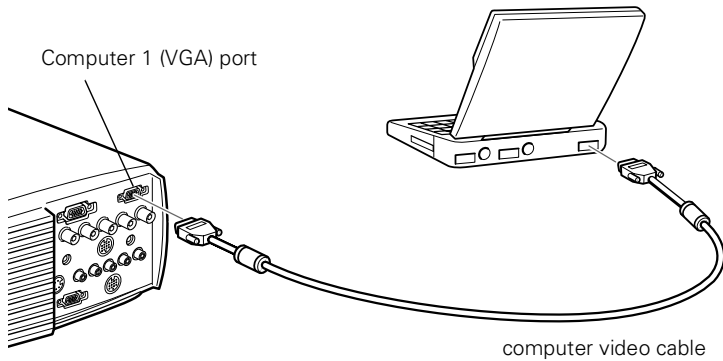

2. Make sure the DVI/VGA switch on the back panel is flipped to the right, as shown. If necessary, use the tip of a ballpoint pen to slide it over.

DVI/VGA switch (slide to right)

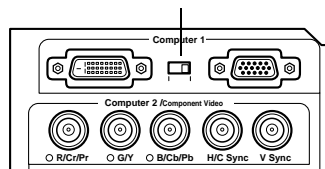

3. Connect the other end of the video cable to the laptop's video (monitor) port.
4. Tighten the screws on the connectors.

If you don't need to make any other connections, you can plug in your projector and turn it on. See page 40 for instructions.

## Connecting the Mouse and Serial Cables

To use the remote control as a mouse or use the EMP Link V software, follow the steps below. This illustration shows the connections you'll be making:

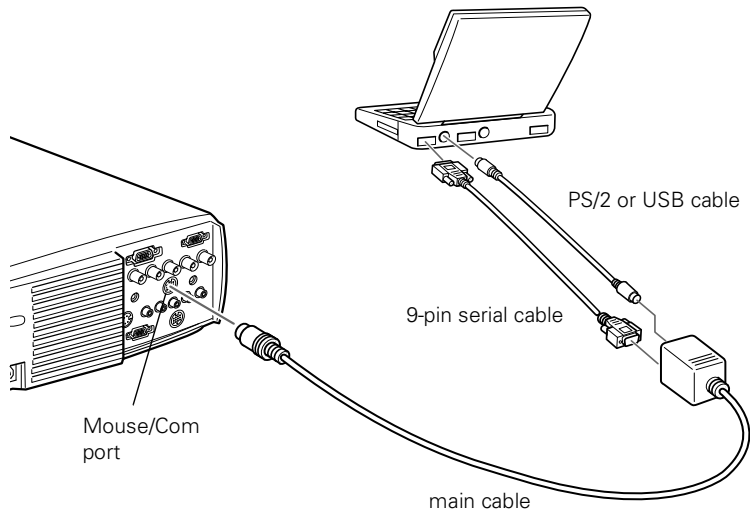

1. Connect the round end of the main cable to the projector's **Mouse/Com** port, as shown.
2. To use the remote control as a wireless mouse, connect the PS/2 or USB cable included with the projector to the **MOUSE** terminal on the square end of the main cable.

### **note**

*If your laptop uses a serial mouse, perform steps 2 and 3 using the PC serial mouse cable instead of the PS/2 or USB cable.*

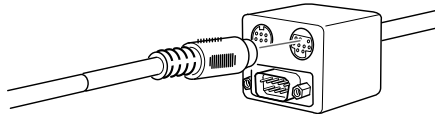

3. Connect the 6-pin (mini-DIN) end of the PS/2 mouse cable to the external mouse port or connect the USB cable to the USB port on your laptop.

4. To use the EMP Link V software, or to program new effects for the Effects buttons on the remote control, connect one end of the PC serial cable to the **SERIAL** terminal on the main cable.

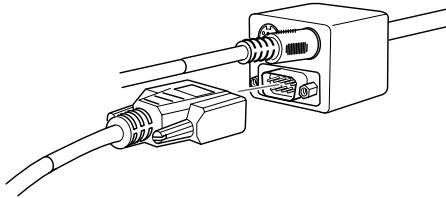

### **note**

*You won't be able to use EMP Link V if your laptop has only one serial port that's being used to support a serial mouse.*

5. Connect the other end of the serial cable to the serial port on the back of your computer.
6. Tighten the screws on the connectors.

### **Connecting the Audio Cable**

1. If you'll be using audio, connect one end of the 3.5-mm audio cable to the **Audio** port on the projector.

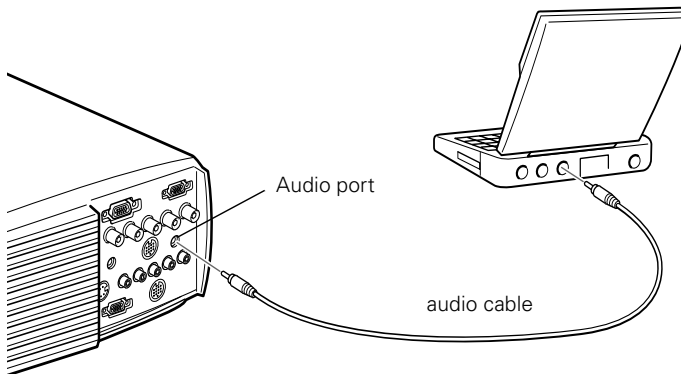

2. Connect the other end of the audio cable to your laptop's headphone jack. (Jack locations vary; see your computer manual if you're not sure of which jack to use.)

## **note**

*Macintosh configurations vary. See your computer manual for the location of the ports needed to connect your projector.*

*You cannot currently use the EMP Link V software with a Power Macintosh G3, G4, or iMac. Check with your dealer for future support.*

## **Connecting to a Desktop Macintosh**

To connect the projector to your desktop Macintosh, you need to:

- Connect the computer video cable and computer monitor cable
- Connect the mouse and/or serial cable (if you want to use the remote control as a mouse or use the EMP Link V software)
- Connect the audio cable (if you'll be projecting with audio)

Follow the steps in each section for the cables you need to connect. Before beginning, turn off the projector and computer if they are on.

### **Connecting the Video and Monitor Cables**

This illustration shows the connections you'll be making. (You may not need to use the adapters as shown.) For details, follow the steps below.

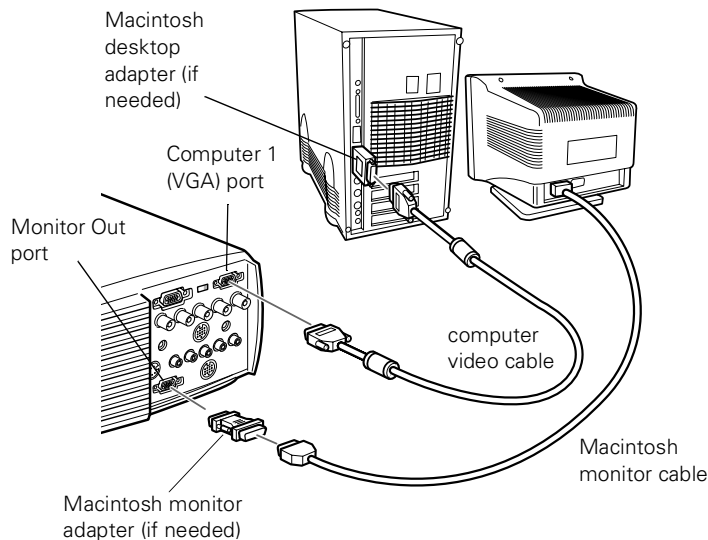

1. Disconnect the monitor cable from the video port on the back of the Macintosh.
2. Connect one end of the computer video cable to the projector's Computer 1 (VGA) port, as shown.

3. Make sure the DVI/VGA switch on the back panel is flipped to the right, as shown. If necessary, use the tip of a ballpoint pen to slide it over.

DVI/VGA switch (slide to right)

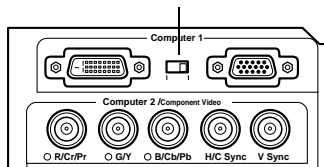

4. Connect the other end of the computer video cable to the video port on the Macintosh. If it doesn't fit, you may have to use the Macintosh desktop adapter included with your projector.

To use the adapter, remove its cover as shown and set its DIP switches according to the resolution you want to use, such as 16-inch mode. See your Macintosh documentation for instructions.

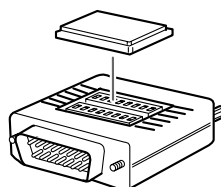

Replace the cover and connect the adapter to the free end of the computer video cable. Then plug the cable (with the adapter) into the video port on your Macintosh.

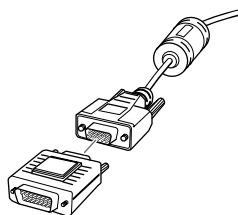

5. If you also want to view the presentation on your computer's monitor, connect the monitor cable to the projector's **Monitor Out** port. (If necessary, attach the Macintosh monitor adapter to the monitor cable, as shown below, and then connect the adapter to the projector's **Monitor Out** port.)

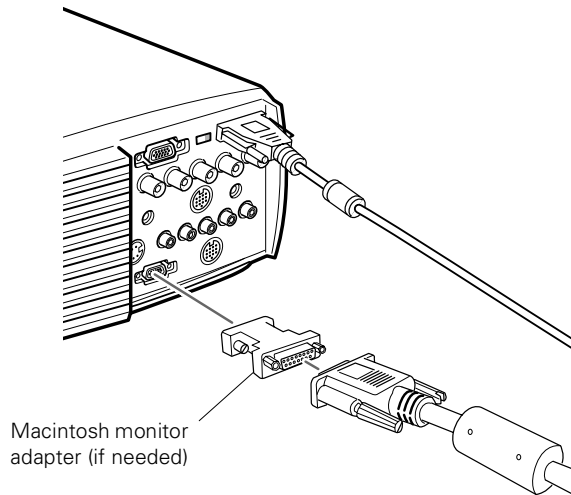

6. Tighten the screws on the connectors.



## Connecting the Mouse and Serial Cables

To use the remote control as a mouse or use the EMP Link V software, follow the steps below. This illustration shows the connections you'll be making:

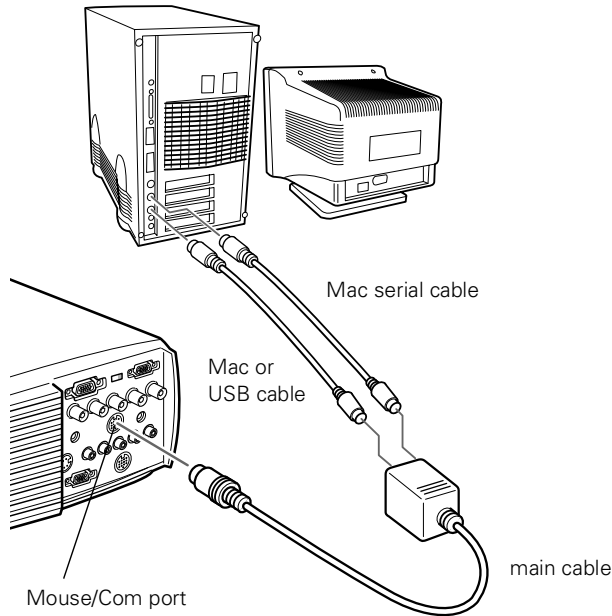

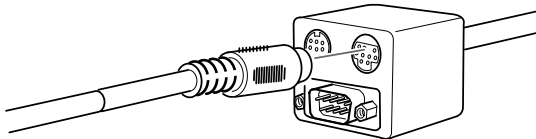

1. Connect the small end of the main cable to the projector's **Mouse/Com port**.
2. To use the remote control as a wireless mouse, connect one end of the projector's Mac mouse or USB cable to the **MOUSE** terminal on the square end of the main cable.

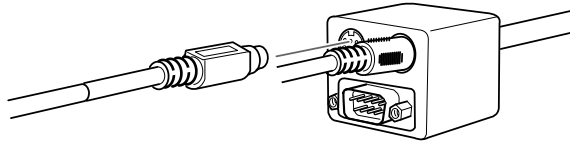

3. Disconnect your Macintosh's mouse cable. Connect the other end of the projector's Mac mouse or USB cable to the mouse or USB port on your Macintosh.

4. To use the EMP Link V software or to program new effects for the Effects buttons on the remote control, connect one end of the Mac serial cable to the **MAC SERIAL** terminal on the main cable.



5. Connect the other end of the Mac serial cable to the  printer or  modem port on the back of your Macintosh.

### *Connecting the Audio Cable*

1. If you'll be using audio, connect one end of the 3.5-mm audio cable to the **Audio** port on the projector.

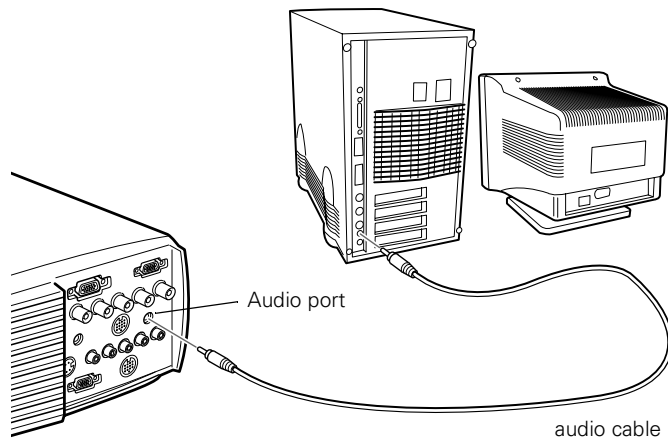

2. Connect the other end of the audio cable to the audio-out port on your computer.

## Connecting to a PowerBook

Your PowerBook must have video-out capability in order to connect to the projector.

To connect the projector to your PowerBook, you need to:

- Connect the computer video cable
- Connect the mouse and/or serial cable (if you want to use the remote control as a mouse or use the EMP Link V software)
- Connect the audio cable (if you'll be projecting with audio)

Follow the steps in each section for the cables you need to connect. Before beginning, turn off the projector and computer if they are on.

### Connecting the Video Cable

This illustration shows the connections you'll be making. For details, follow the steps below.

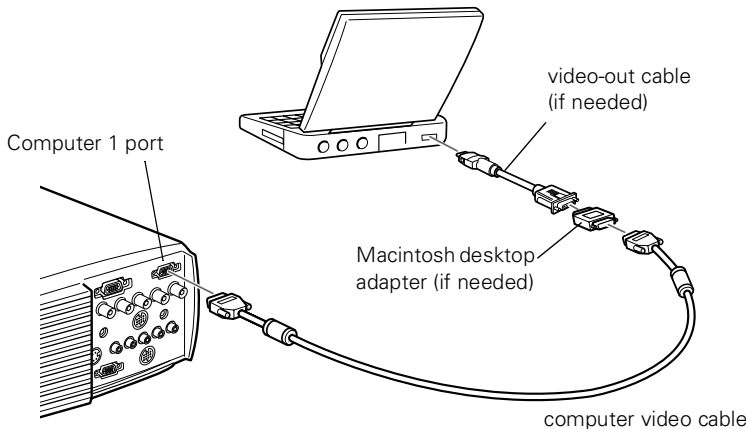

1. Connect one end of the computer video cable to the projector's Computer 1 (VGA) port, as shown.
2. Make sure the DVI/VGA switch on the back panel is flipped to the right, as shown. If necessary, use the tip of a ballpoint pen to slide it over.

DVI/VGA switch (slide to right)

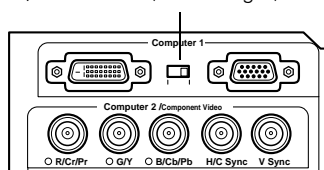

### note

*PowerBook configurations vary, so the location of your computer's ports may not match the illustrations. See your PowerBook manual for the port locations if necessary.*

### note

*Some older PowerBooks may need a Macintosh desktop adapter (included with your projector) and a special video-out cable (available from Apple). Check your PowerBook manual to determine the type of connections needed.*

3. Connect the other end of the cable to the video-out port or monitor port on your PowerBook. If you can't connect the cable to your PowerBook, you may need to use the Macintosh desktop adapter that came with your projector.

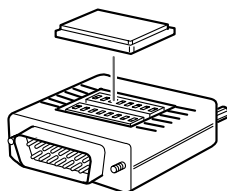

To use the adapter, remove its cover as shown and set its DIP switches according to the resolution you want to use, such as 16-inch mode. See your Macintosh documentation for instructions.

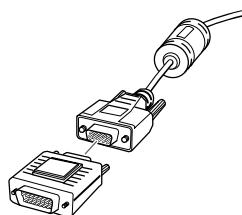

Replace the cover and connect the adapter to the free end of the computer video cable. Then plug the cable (with the adapter) into the video port on your Macintosh.

If your PowerBook requires a video-out cable, connect its larger end to the adapter, as shown below. Then plug the video-out cable into the video port on your Macintosh.

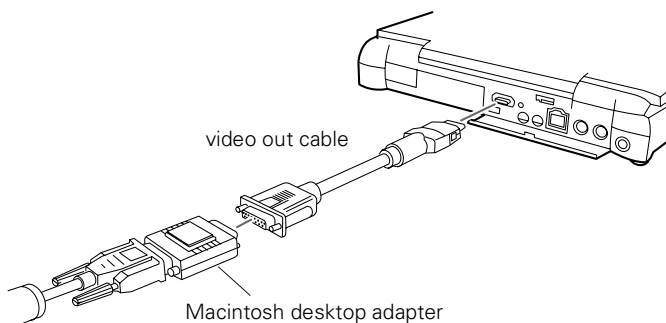

### **note**

*After turning on the projector and computer, you'll need to choose *Mirroring* or *Arrange* in the Display Control Panel if you want the PowerBook (as well as the projector) to display video. See page 42 for instructions.*

4. Tighten the screws on the connectors.

If you don't need to make any other connections, you can plug in your projector and turn it on. See page 40 for instructions.

## Connecting the Mouse and Serial Cables

To use the remote control as a mouse or use the EMP Link V software, follow the steps below. This illustration shows the connections you'll be making:

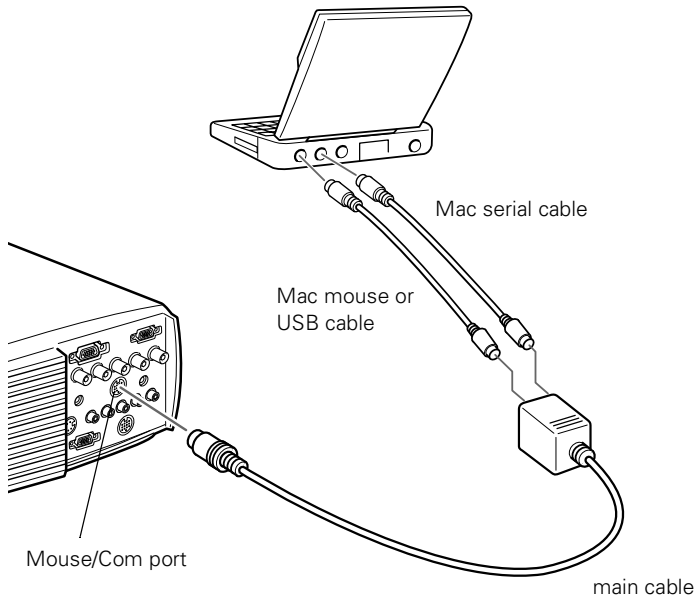

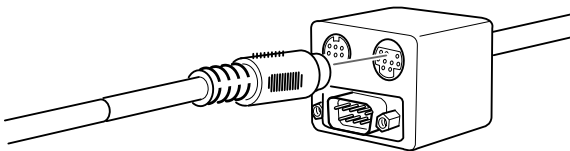

1. Connect the round end of the main cable to the projector's **Mouse/Com port**, as shown.
2. To use the remote control as a wireless mouse, connect one end of the projector's Mac mouse or USB cable to the **MOUSE** terminal on the square end of the main cable.

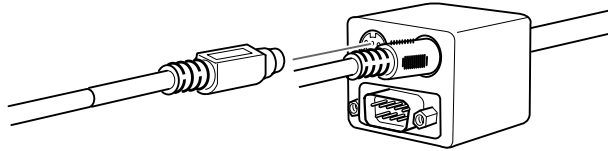

3. Connect the other end of the Mac mouse or USB cable to the mouse or USB port on the back of the PowerBook.

4. To use the EMP Link V software or program new effects for the Effects buttons on the remote control, connect one end of the Mac serial cable to the **MAC SERIAL** terminal on the main cable.



5. Connect the other end of the serial cable to the  printer/  
 modem port on the back of your PowerBook.

### *Connecting the Audio Cable*

1. If you'll be using audio, connect one end of the 3.5-mm audio cable to the **Audio** port on the projector.

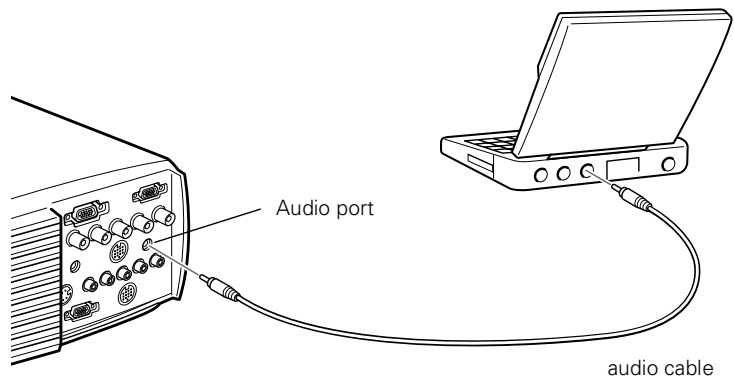

2. Connect the other end of the audio cable to the audio-out port on your PowerBook.

## Making Other Computer Connections

If you want to connect a computer using the BNC cable or connect a high-end workstation or a Digital Visual Interface (DVI) source, follow the instructions below.

### Connecting a Computer Using the BNC Cable

Follow these steps to connect a computer to the **Computer 2/Component Video** interface using the BNC cable:

1. Connect the VGA (D-sub 15-pin) end of the cable to your computer's video port.
2. Connect the five connectors at the other end of the cable to the projector's **R/Cr/Pr** (red), **G/Y** (green), **B/Cb/Pb** (blue), **H/C Sync** (horizontal sync), and **V Sync** (vertical sync) ports, shown below.

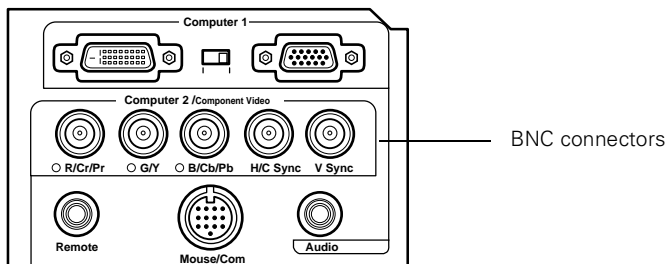
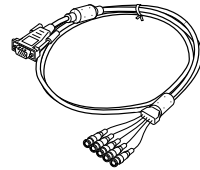

3. To display images properly, make sure the BNC parameter in the projector's Setting menu is set to **RGB**. See page 69.
4. If you want to hear computer-audio through the projector, you'll need an RCA-to-3.5 mm stereo cable (available for purchase from your electronics store or video dealer). Insert the cable's 3.5-mm plug into your computer's audio-out port. Then attach the RCA connectors at the other end of the cable to the **S-Audio** and **Audio2** ports of the projector.

## Connecting to a High-End Workstation

Your PowerLite projector is capable of remapping input resolutions up to  $1600 \times 1200$  pixels. Since  $1280 \times 1024$  pixels is the default resolution for most leading workstations, your projector is ideal for displaying workstation video output.

There is no standard for workstation video output. Workstations that follow the SXGA standard and use the HD15 (standard VGA) connector won't need an adapter cable or any special connection device. However, your system may vary; contact your computer dealer if you need help connecting your workstation.

### **note**

*You won't be able to view images on a separate monitor when the DVI port is in use.*

## Connecting to a DVI Video Source

The projector's Digital Visual Interface (DVI) receives pictures directly from your computer in digital format. This lets the projector display images of greater clarity than can be achieved using a standard analog VGA connection.

To project images in digital video format, follow these steps:

1. Connect the computer's DVI cable to the projector's DVI port.

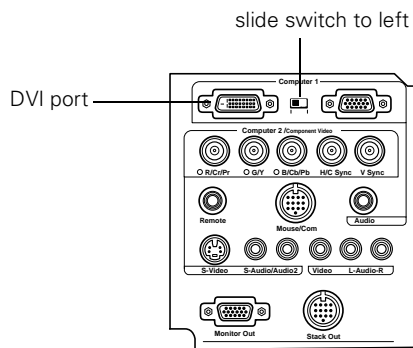

2. Using the tip of a pen or a small screwdriver, slide the DVI/VGA interface switch to the left. (If you need to use the projector's VGA port again, be sure to slide the switch back to the right.)

If you want to connect audio for this computer, you can use the Audio port on the back of the projector.



## Connecting to Other Video Sources

You can connect a VCR, camcorder, laser disc player, DVD player, digital camera, or any other compatible video source to your projector.

The projector supports HDTV, NTSC, PAL, and SECAM video formats, and automatically detects and identifies the video format. However, you can specify that a single broadcast format be detected. (See page 65.) Note that the projector will then be able to detect only one type of video signal.

The projector can receive composite video, S-Video, or component video. You can connect the projector to one or more of these video sources at the same time. If all three are connected, the projector automatically selects S-Video as the video source.

The type of cable you use depends on whether you have composite video, S-Video, or component video. For composite video, use the RCA cables supplied with the projector. For S-Video, use the S-Video cable supplied with your video device or obtain one from your computer or video equipment dealer. For component video, use the BNC-style cable that came with your video source. See the following illustration if you're unsure of which type of connectors you have.

### **note**

*The projector is not compatible with cable TV-style F connectors.*

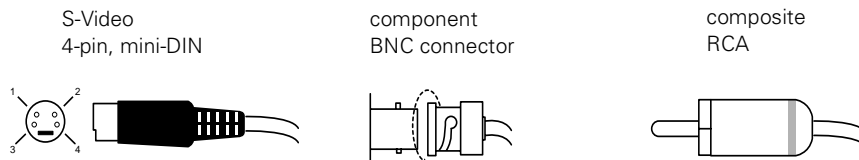

Follow the instructions below for your type of connection.

The Computer2/Component Video port and the S-Video port share the same audio input. So if you have connected a video source to both interfaces, note that you can use audio from only one of them.

## Connecting RCA Cables

Before starting, make sure the projector and your VCR or other video source are turned off.

1. Connect the yellow RCA plug on one end of the RCA video cable to the projector's Video port. Connect the other end of the cable to the video-out port of your video source.

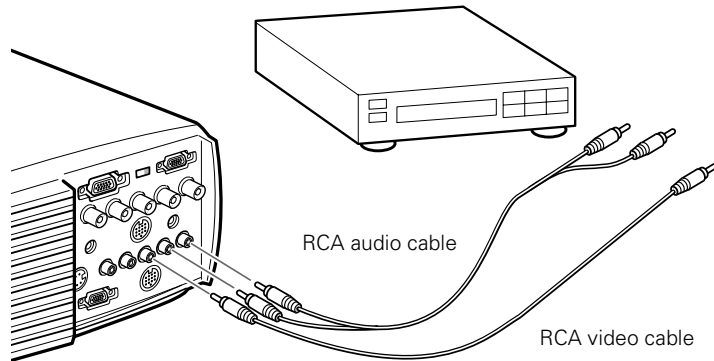

2. If you'll be using audio, connect the RCA audio cable to the left and right Audio ports of the projector (insert the white plug into the L port and the red plug into the R port). Connect the plugs at the other end of the cable to the audio output ports of the video source.

## Connecting S-Video or Component Video

Before starting, make sure the projector and your VCR or other video source are turned off.

1. For S-Video, insert one end of an S-Video cable into the projector's **S-Video** connector. Insert the other end into the S-video-out port of your video source.

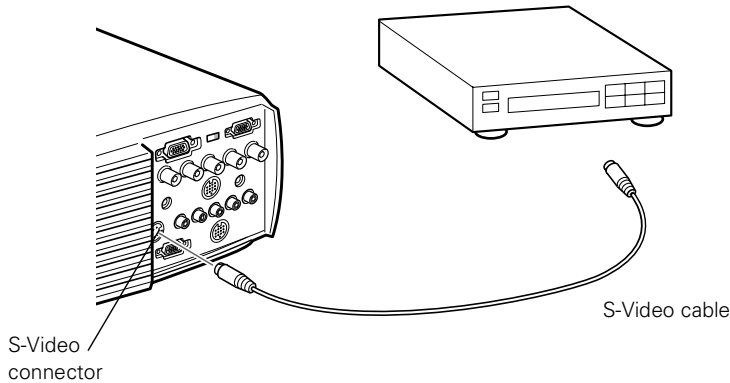

For component video, connect the three ends of a BNC cable into the projector's **R**, **G**, and **B** ports. (Don't connect the cables to the projector's **H/C Sync** or **VSync** ports.) Insert the opposite ends of the cable into the corresponding ports of your video source. If the image doesn't display properly, you may need to change the BNC parameter in the projector's Setting menu (see page 69).

2. If you'll be using audio, connect the RCA audio cable to the **S-Audio** and **Audio2** ports of the projector. Connect the plugs at the other end of the cable to the audio output ports of the video source.

---

### **note**

*Contact your video manufacturer or other video or electronics dealer to obtain a component video cable.*

---



# 2

## *Using the Projector*

Once you have connected your projector to your other equipment (as described in Chapter 1), you're ready to turn it on, adjust the image, and give your presentation. This chapter covers the following:

- Turning on the projector and other equipment
- Adjusting the image
- Using the remote control
- Zooming your image with the remote
- Controlling the projector
- Drawing on the screen
- What to do when the lights flash
- Using the on-screen help
- Shutting down the projector

## Turning On Your Equipment

Make sure your projector and other equipment are set up and connected correctly, as described in Chapter 1. Then turn on your projector, as described below, followed by any equipment you've connected to it. You can turn on your computer and video equipment in any order, but if you have more than one computer or video source connected, you may have to switch to the desired source as described on page 51.

### Turning On the Projector

Follow these steps to turn on the projector:

1. Connect one end of the power cord to the projector's power inlet.
2. Connect the other end to a grounded electrical outlet. The power light on the projector's control panel starts flashing orange and then stays orange, indicating that the projector is receiving power but not yet turned on.
3. Remove the lens cap.
4. Press the red **Power** button on top of the projector (or the remote control) to turn on the projector. (If you are using the remote, make sure it is turned on. See page 48 for more information.)

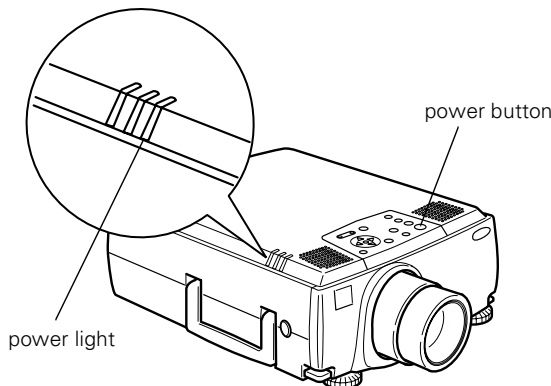

#### **warning**

*Never look into the lens when the lamp is on. This can damage your eyes, and is especially dangerous for children.*

The power light flashes green as the projector warms up, and the projection lamp comes on in about 30 seconds. The power light stays green, and you may see a blue screen with the message **No Signal** displayed. This is normal.

5. Do one of the following:

- If you've connected more than one computer and/or video source, you may need to press the **Computer** or **Video** button on top of the projector to select the correct source. (Allow a few seconds for the projector to sync up after pressing the button.)

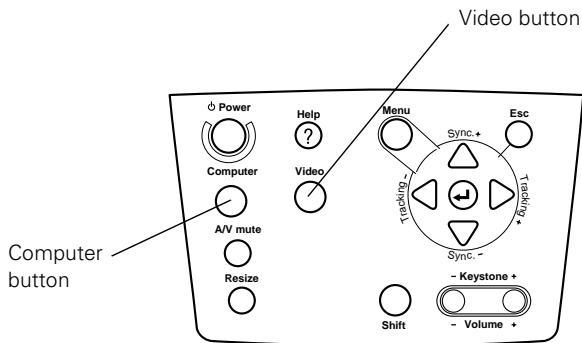

These buttons switch the display between the video source(s) and the computer source(s).

- Turn on or restart your computer. In a few moments, you should see your computer display projected.

(Windows only: If you see a New Hardware Found message saying that it has found a plug-and-play monitor, click **Cancel**.)

- If you're projecting a video, turn on your video source and press the **Play** button.

If a projected image fails to appear, see the next section for help.

Once you see your image, turn to page 44 for instructions on focusing and making other image adjustments.

When you're done with your presentation, shut down the projector as described on page 58. Shutting down the projector correctly prevents premature lamp failure and possible damage to the projector from overheating.

## ***What To Do If You See a Blank Screen***

If you see a blank screen or a blue screen with the message **No Signal** after turning on your computer or video source, do one of the following:

- Make sure the cables are connected correctly, as described in Chapter 1.
- Make sure the power light is green and not flashing and the lens cap is off.
- If you've connected more than one computer and/or video source, you may need to press the **Computer** or **Video** button on top of the projector to select the correct source. (Allow a few seconds for the projector to sync up after pressing the button.)
- Try restarting your computer.

### ***If you're using a PowerBook:***

You may need to set up your system to display on the projector screen as well as the LCD screen. Follow these steps:

1. From the Apple menu, select **Control Panels**, then click **Monitors and Sound**.
2. Click the **Arrange** icon.

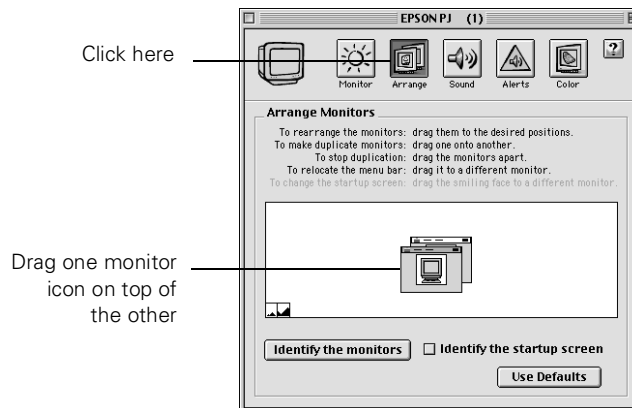

3. Drag one monitor icon on top of the other.



If this option isn't available, you may need to select one of the Simulscan resolution settings:

1. Click the **Monitor** icon.

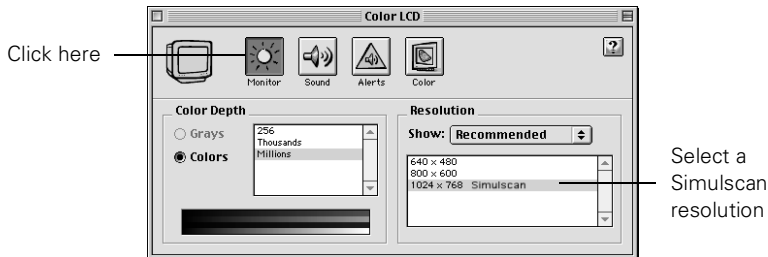

2. Select a **Simulscan** resolution as shown. (Allow a few seconds for the projector to sync up after making the selection.)

### *If you're using a PC laptop:*

- Press the function key that lets you display on an external monitor. It's often identified with an icon such as  or labelled CRT/LCD. You may have to hold down the Fn key while pressing it. Check your laptop's manual or online help for details.

On most systems, the  or CRT/LCD key lets you toggle between the LCD screen and the projector, or display on both at the same time. Allow a few seconds for the projector to sync up after pressing it.

- Depending on your computer's video card, you might need to use the Display utility in the Control Panel to make sure that both the LCD screen and external monitor port are enabled. See your computer's documentation or online help for details.

## **Sleep Mode**

When the projector has not received any input signals for 30 minutes, it automatically turns off the projector lamp and enters "sleep mode." In sleep mode, only a minimum amount of the projector's circuitry remains on. This conserves electricity, cools the projector, and extends the life of the lamp. When you are ready to start projecting again, press the **Power** button. If you are done using the projector, unplug the power cord.

### **note**

*When the projector is in sleep mode, the power light is orange. If necessary, you can disable sleep mode in the Setting menu. See page 69.*

## *Adjusting the Image*

Once you see your image, you'll need to make certain adjustments:

- To focus or zoom your image, see below.
- If only part of a computer image is displayed, you may need to press the **Resize** button. See page 45 for more information.
- If the image is too high or too low, you can reposition it. See page 46.
- If the image isn't square, see page 47.
- If the image is flickering or "noisy," see page 47.

### ***Focusing and Zooming Your Image***

Rotate the focus ring to sharpen the image.

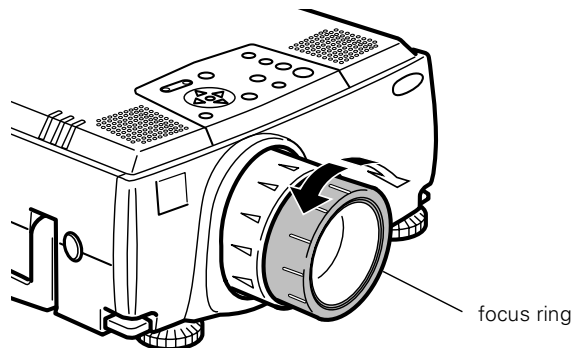

Rotate the zoom ring to enlarge or reduce the image.

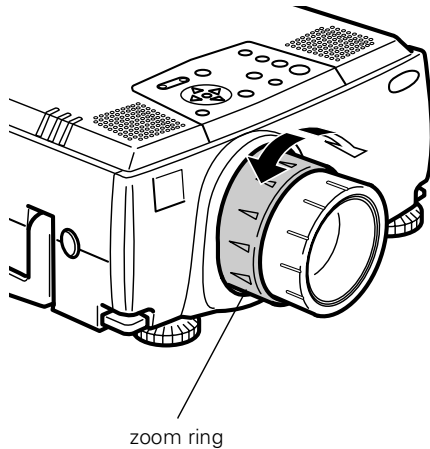

If the image still isn't large enough, you may need to move the projector farther away from the screen. You can also use the **E-Zoom** button on the remote control to zoom in on a portion of the image. See page 50 for instructions.

## **Resizing the Image**

If only part of your computer screen is displayed, your computer may be set for a higher resolution than the projector's "native" display: 1024 × 768 pixels (PowerLite 8100i) or 1280 × 1024 (PowerLite 9100i). You can resize the image to fit the resolution of your projector.

- Press the **Resize** button on the remote control or the control panel. The screen image is automatically compressed.
- Continue pressing the **Resize** button to pan around the screen in the original resolution.

If you're projecting from video equipment, pressing the **Resize** button switches the aspect ratio between 4:3 and 16:9. If you have zoomed in on your image, you can also use the **Resize** button to switch it back to the original display size.

---

### **note**

*You can also resize your image with the **Resize** button when you're projecting from a VCR or other video source.*

---

## ***Adjusting the Height of the Image***

You can adjust the height of the image using the lens shift knob on the side of the projector and the projector's feet.

### ***Using the Lens Shift Knob***

Use the lens shift knob on the side of the projector to raise or lower the projected image. Press the knob to make it pop out; then turn it clockwise or counterclockwise to move the lens up or down. When you're finished, press the knob back in.

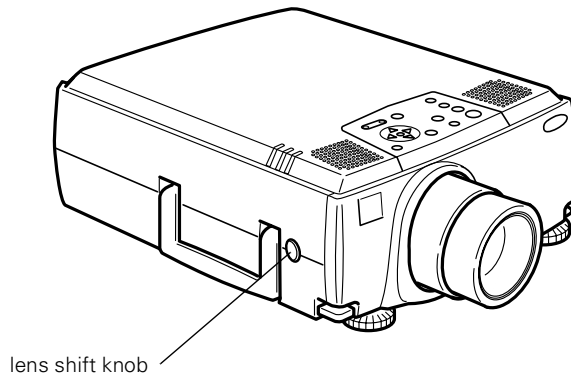

### ***Using the Projector's Feet***

If the image is too low, you can extend the projector's feet to raise the lens. Follow these steps:

#### ***caution***

*Do not hold the projector by the lens; this can damage it.*

1. Stand behind the projector and hold up the front while you squeeze the blue foot release levers against the projector. This unlocks the feet.

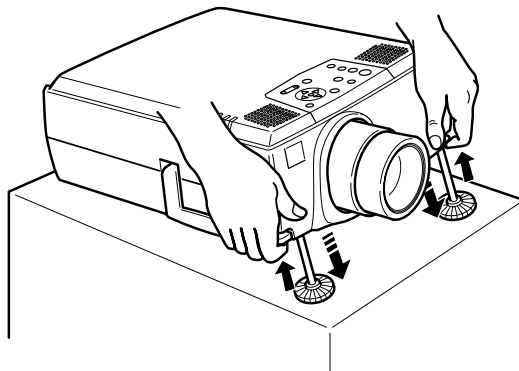





2. Raise or lower the projector until the image is positioned where you want it.
3. Release the levers to lock the feet in the new position and set the projector down gently.
4. To fine-tune the height of the projector, turn the feet. Turn them clockwise to raise the projector and counterclockwise to lower it.

If the image shape becomes distorted after you adjust the height, see the following section.

## ***Adjusting the Image Shape***

If the projected image isn't square or has a "keystone" shape, do one or more of the following:

- If your image looks like  or , you've placed the projector off to one side of the screen, at an angle. Move it directly in front of the center of the screen, facing the screen squarely.
- If your image looks like  or , press the + or – side of the **Keystone** button to correct the shape of the image. After correction, your image will be slightly smaller.

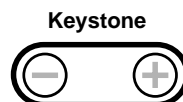

You can also perform electronic keystone correction using the projector's Setting menu. See page 69.

## ***Adjusting the Tracking and Synchronization***

If you're projecting from a computer and you notice vertical stripes or the image is flickering or noisy, you can increase the clarity by pressing the **↔** button on the control panel or the **Auto** button on the remote control. This resets the projector's tracking, sync, and position settings. If necessary, you can also correct the image manually using the **Tracking** and **Sync** buttons on the control panel.

## note

Images will be projected more vividly if you adjust the Tracking before the Sync.

- Press the Tracking – and Tracking + buttons to eliminate the vertical stripes.

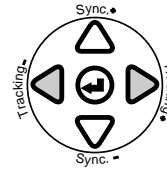
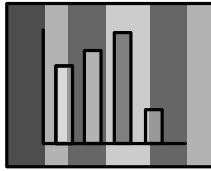

- Press the Sync – and Sync + buttons to eliminate flashing, blurring, or vertical noise on the screen image.

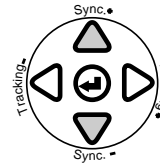
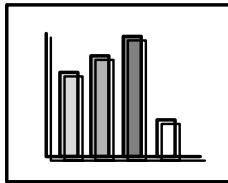

## note

You must also be within  $\pm 30^\circ$  vertically and  $\pm 15^\circ$  horizontally from the front or rear sensor.

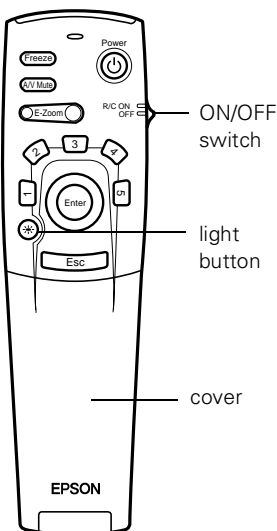

## Using the Remote Control

The remote control lets you access your projector's features from almost anywhere in the room—up to 32 feet away. You can use it to turn the projector on and off, zoom the image, and display the projector's menus, for example.

If you have connected the mouse cable (as described in Chapter 1), you can also use the remote control as a wireless mouse to run your presentation.

Before you can use the remote control, you need to install the batteries, as described on page 12. Then follow these steps:

1. Push up the R/C switch on the side of the remote control to turn it on.
2. Press the round light  button. The other buttons on the remote light up temporarily. If they don't light up, you need to change the batteries. See page 12 for instructions.
3. Point the remote at the projector or at the screen.

4. Press the button for the function you want to use. See pages 50 to 55 for more information.

For some functions, you need to use the **Enter** button like a mouse to navigate on the screen. Press on the edge of the button with your thumb. Or, grasp it between your thumb and finger and tilt it in the direction you want to move.

5. To access additional buttons, pull down the cover below the **Esc** button. (See pages 50 to 53 for instructions on using these buttons to control the projector.)

The projector may not respond to remote control commands in these conditions:

- You are too far away or not within 30° to the left or right of and 15° above or below the front or rear sensor.
- The R/C (remote control) switch is in the **OFF** position
- Batteries are weak
- Ambient light is too bright
- A fluorescent light is shining into the infrared receiver
- A strong light source (such as direct sunlight) shines into the infrared receiver
- Other equipment emitting infrared energy is present (such as a radiant room heater)

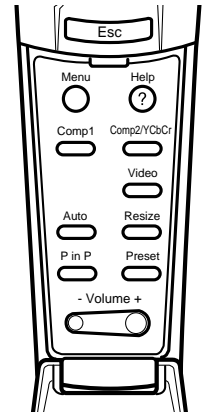

## ***Using the Remote Control as a Wireless Mouse***

Using the remote control as a wireless mouse gives you more flexibility; you don't need to stay near your computer or the projector. First make sure you have connected the mouse cable between the projector and your computer with the main cable, as described in Chapter 1.

Note that your computer's mouse is disabled when you connect the projector's mouse cable. If you have a laptop, you cannot use an external mouse; however, you may still be able to use the computer's built-in mouse pointer.

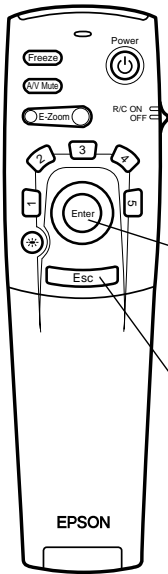

Press here to move the pointer

Press here to right-click

- To move the mouse pointer on the screen, aim the remote at the screen and press on the edge of the **Enter** button with your thumb. Or, grasp it between your thumb and finger. This button works like the mouse button on many laptop keyboards.
- To click, press down on the center of the **Enter** button. This is the equivalent of a left mouse click.
- To right-click, press the **Esc** button.
- To double-click, press down twice on the **Enter** button.
- To click and drag, press down on the **Enter** button and then tilt it in the direction you want to drag.
- To change slides in a PowerPoint® presentation (in Slide Show mode), press down on the **Enter** button.

## *Zooming Your Image with the Remote*

You can zoom in on a portion of the image using the **E-Zoom** button on the remote control.

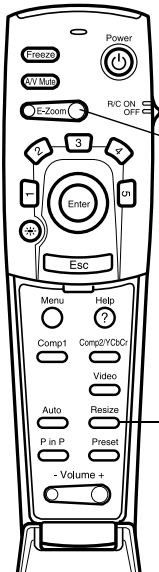

Zoom in or out

Resize

1. Press the right side of the **E-Zoom** button to zoom in on your image.
  - Press the button repeatedly to enlarge it up to four times in 24 steps.
  - Press and hold the button to zoom in to the size you want.
2. Use the **Enter** button to pan around the screen if necessary.
3. Press the left side of the **E-Zoom** button to zoom out. You can press the button repeatedly, or press and hold to zoom all the way out. You can also press the **Resize** button to return to the original size.



# Controlling the Projector

While giving your presentation, you may want to switch between video sources, adjust the volume, pause the action or sound, or display a picture within your current video display. Make sure you have set up your projector and connected your audio or video source as described in Chapter 1.

## Selecting Your Video Source

If the projector is connected to more than one computer and/or video source, you can use the buttons on the remote control or the control panel to switch between the different sources.

On the control panel, press the **Computer** button to switch between the computer sources and press the **Video** button to switch between standard (composite) video, S-Video, and component video (BNC).

On the remote control:

- Press the **Video** button to switch between a standard composite video source and an S-Video source.
- Press the **Comp1** button to select the Computer 1 source.
- Press the **Comp2/YCbCr** to select the Computer 2 or component video source.

After you select a source, the screen goes dark for a moment before the image appears.

## Adjusting Sound Volume

Using the remote control or the control panel, you can adjust the volume of your video or computer sounds.

- To increase the volume, press on the right (+) side of the **Volume** button.
- To reduce the volume, press on the left (-) side of the **Volume** button.

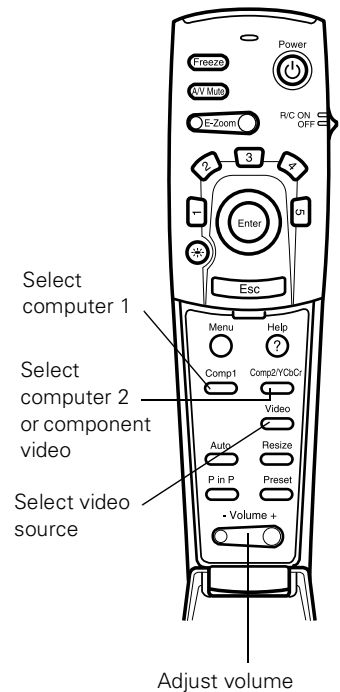

## Stopping Action

You can use the remote control to stop the action in your video or computer.

- Press the **Freeze** button to stop the action and keep the current image on the screen. The sound will continue.
- Press the **Freeze** button again to re-start it.

## Turning Off the Picture and Sound

You can use the **A/V Mute** button on the remote control or control panel to turn off the image (and sound) and darken your screen. This is useful if you want to temporarily re-direct your audience's attention without the distraction of a bright screen.

- To turn off the picture, press the **A/V Mute** button. The screen goes dark.
- To turn the image back on, press the button again.

You can also assign a user logo or image to the **A/V Mute** button so it displays on the screen whenever you press the **A/V Mute** button. See “Creating a Screen Logo or Image” on page 72.

## Displaying Picture-in-Picture Video

You can open a small video window on your computer image, and view a video at the same time as your computer presentation. Make sure you have connected your VCR or other video source as described in Chapter 1.

1. Press the **P in P** button on the remote control. The screen may go dark for a moment, and then your video image appears in a small window on the screen. A menu appears in the lower left corner of the screen.
2. Press the side of the **Enter** button (or grasp it between your thumb and finger) to move the video window on the screen. You can use the **E-ZOOM** button to enlarge or reduce the video window.

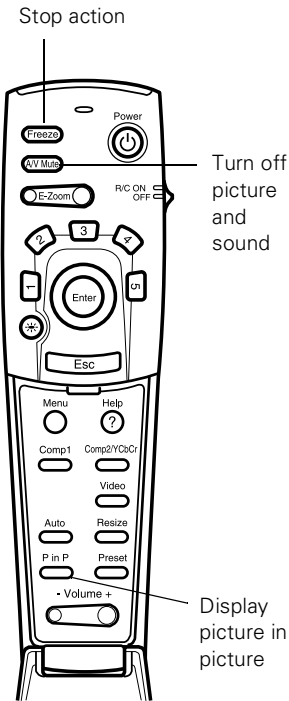

### note

You can also select the **P in P** source through the projector's Setting menu. See page 69.

- When the window is located and sized the way you want, press the **Enter** button. The menu disappears, and your video plays on the screen.



video window

- When you're finished viewing the picture-in-picture, press the **P in P** button again. The video window disappears.

## *Drawing on the Screen*

The projector's drawing controls or “special effects” let you highlight areas on the screen using the numbered buttons on the remote control. You can use these features to annotate your presentation slides or call attention to your most important points. Four types of drawing tools (and an Erase function) are available:

- Arrow or cursor stamp (button 1)
- Box (button 2)
- Spotlight (button 3)
- Bar (button 4)
- Erase (button 5)

You can select different drawing effects through the Effect menu. See page 68 for instructions.

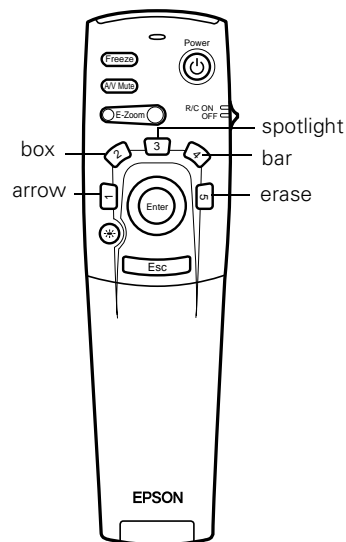

## ***Using the Cursor/Stamp Arrow***

You can use the cursor stamp tool as a pointer and place cursor stamps anywhere on your screen. You can choose from three types of stamps.

### **note**

*You can use the projector's Effect menu to select different cursor stamps. See page 68.*

1. To activate the cursor stamp, press button 1 on the remote control. A green pointer appears in the upper left corner of the screen. To try a different stamp, press 1 again. Press 1 again to see the third one.
2. Press the side of the **Enter** button to move the pointer wherever you want it.
3. To “paste” the pointer on the screen, press down in the center of the **Enter** button. You can then continue to work with another pointer, moving it around the screen or pasting it wherever you want.
4. To erase the pointers pasted on the screen, press button 5.
5. To cancel the cursor stamp feature, press **Esc**.

## ***Drawing Boxes***

You can draw outline boxes on the screen to highlight areas of your presentation or video.

### **note**

*You can use the projector's Effect menu to change the color and shape of the box. See page 68.*

1. To activate the box tool, press button 2 on the remote control. A small pink square appears in the upper left corner of the screen. This is the “box-drawing” tool.
2. Press the side of the **Enter** button to move the square where you want to begin drawing the box.
3. Press down in the center of the **Enter** button. You see a corner mark on the screen; this defines one corner of the box.
4. Press the side of the **Enter** button to drag the square to where you want the opposite corner of the box to be.
5. Press down in the center of the **Enter** button. You see the box outlined on the screen.

You can continue placing boxes on the screen by repeating steps 2 through 5.

6. To erase the box(es), press button 5.
7. To cancel the box drawing feature, press Esc.

## ***Spotlighting Your Image***

With the Spotlight tool, you can place a spotlight box on part of the screen image.

1. To activate the spotlight tool, press button 3 on the remote control. A box of light appears on part of the image.
2. Press the side of the Enter button to move the spotlight where you want it to be.
3. To remove the spotlight, press Esc.

You can change the size of the Spotlight using the Effect menu; see page 68.

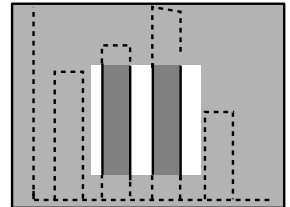

## ***Drawing Horizontal and Vertical Bars***

With the bar tool, you can draw bold horizontal or vertical lines on the screen to underline or highlight your presentation points. You can choose from three types of bars.

1. To activate the bar tool, press button 4 on the remote control. A pink horizontal bar appears across the screen. If you want a vertical bar, press 4 again. If you want to try another horizontal bar, press 4 again.
2. Use the Enter button to move the bar up and down the screen (or left and right if you are using the vertical bar).
3. To cancel the bar drawing feature, press Esc.

---

### ***note***







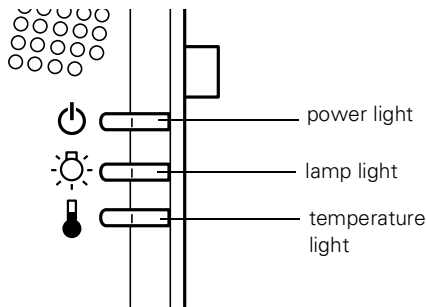



*You can change the color and width of the bars using the Effect menu. See page 68.*

---

## What To Do When the Lights Flash



The lights on top of the projector indicate the projector's status and let you know when a problem occurs.

Light	Status	Description and action
	orange	The projector is in sleep mode. You can unplug it or press the <b>Power</b> button to turn it on.
	flashing green	The projector is warming up. Wait for the image to appear.
	green	The projector is operating normally.
	flashing orange	The projector is cooling down. You can't turn the projector on or unplug it when the light is flashing.
	red	Power is cut off because of an internal problem. Contact EPSON for help.
	flashing orange	The lamp is almost burned out. This is a good time to replace it. See Chapter 4 for instructions.
	flashing red	The lamp is burned out or there is a problem with the lamp power. Replace the lamp, following the instructions in Chapter 4. (If replacing the lamp does not solve the problem, contact EPSON.)
	flashing orange	The projector is too hot. Turn it off and let it cool before using it.
	red	The projector has turned off automatically because it has overheated. Let it cool for a few minutes, then turn it back on. Make sure there is plenty of space around and under the projector for ventilation. If it continues to overheat, you may need to change the air filter. See Chapter 4 for instructions.
	flashing red	There is a problem with the cooling fan or temperature sensor. Turn off the projector and unplug it. Contact EPSON for help.

## *Using the On-Screen Help*

If you have a problem while setting up or using your projector, you can get help by pressing the blue **? Help** button on top of the projector or the remote control. The following choices are available:

- **Help for the image**  
Tells you how to solve problems with a blank screen, blurry images, brightness, colors, and image shape
- **Help for the sound**  
Provides help for problems with lack of audio
- **Problems with the projector**  
Provides help for problems operating the projector
- **Language selection**  
Lets you choose to display the help information and projector menus in any of 9 different languages

Follow these steps to get help:

1. Press the blue **? Help** button. You see the main help menu.
2. Press the **Sync –** or **Sync +** button (on the control panel) or press down or up on the **Enter** button (remote control) to select the menu you want. You see options for that menu.
3. Use the **Sync –** or **Sync +** button (on the control panel) or press down or up on the **Enter** button (remote control) to highlight the problem you want to solve. Then press the **Enter** button to select the solution(s).

Depending on your choice, you may see another menu, or you may see a list of solutions.

4. To exit the Help system, press the blue **? Help** button on top of the projector.

If none of the Help menu choices solves your problem, see Chapter 5, “Solving Problems.”

## Shutting Down the Projector

### **note**

*When the projector has not received any input signals for 30 minutes, it automatically turns off the projector lamp and enters “sleep mode.” This conserves electricity, cools the projector, and extends the life of the lamp. If you are done using the projector, unplug the power cord. If you want to start projecting again, press the Power button.*

When you’ve finished using the projector, follow the recommended procedure to shut it down. This extends the life of the lamp and protects the projector from possible overheating.

1. If you’ve connected a computer or laptop and it’s displaying only through the projector (the computer’s monitor is disconnected or turned off), shut down the computer first; otherwise you won’t be able to see your computer’s display if you try turning it off after the projector.
2. To turn off the projector, press the red **Power** button on the projector or remote control. You see a confirmation message. (If you don’t want to turn it off, press any other button.)
3. Press the **Power** button again. The power light flashes orange for about a minute as the projector cools down. When the projector has cooled, the orange light stays on and the exhaust fan shuts off.  
  
If you want to turn the projector on again, wait until the orange light stops flashing. Then press the **Power** button.
4. Replace the lens cap and unplug the power cord.
5. If you’re using a VCR or other video source, turn it off after you turn off the projector.
6. Disconnect all equipment, and store the projector in a protective case.

### **caution**

*To avoid damaging the projector or lamp, never unplug the power cord when the power light is green or flashing orange.*



# 3

## *Fine-tuning the Projector*

You can use the projector's on-screen menus to adjust the image, sound, and other features. You can also create your own startup screen, customize the “drawing” tools, and view information about the current display settings and lamp status. This chapter covers the following information:

- Using the menus
- Adjusting the image
- Adjusting the sound
- Customizing the drawing controls
- Customizing projector features
- Creating your own user logo or image
- Viewing information
- Restoring the default settings

---

### *Using the Menus*

The eight projector menus let you adjust and customize the projector features from either the remote control or control panel:

- The Video menu controls the look and quality of the projected image. It lets you adjust the image position and fine-tune settings such as Brightness, Sharpness, and Contrast.
- The Audio menu controls audio features, such as the volume level, treble, bass, and 3D sound.
- The Effect menu lets you change the cursor speed and modify the drawing tools assigned to the Effects buttons on the remote control.

- The Setting menu allows you to set or adjust such projector options as the keystone function, Picture in Picture (P in P) video source, blank screen color, image source message prompt, A/V Mute display option, BNC input source, and sleep mode.
- The Capture menu lets you capture and store a custom image or logo which you can then use as a startup screen or with the A/V Mute display option.
- The Advanced menu allows you to specify additional projector settings, including a language, startup screen, color setting, Comp2 sync termination, and rear or ceiling projection.
- The About menu provides information about H/V frequency, lamp hours, and computer or video selection.
- The Reset All menu lets you restore the factory defaults for all the projector settings.

## Changing Menu Settings

You can use the buttons on the control panel or remote control to access the menus and change settings. Follow these steps:

1. To display the Main menu, press the **Menu** button on the control panel or the remote control.

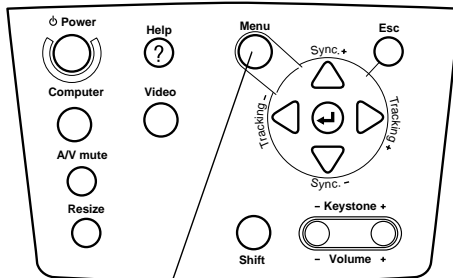

Menu button

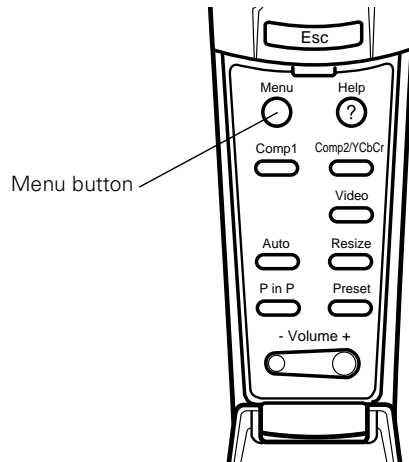

Menu button

You see the Main menu:

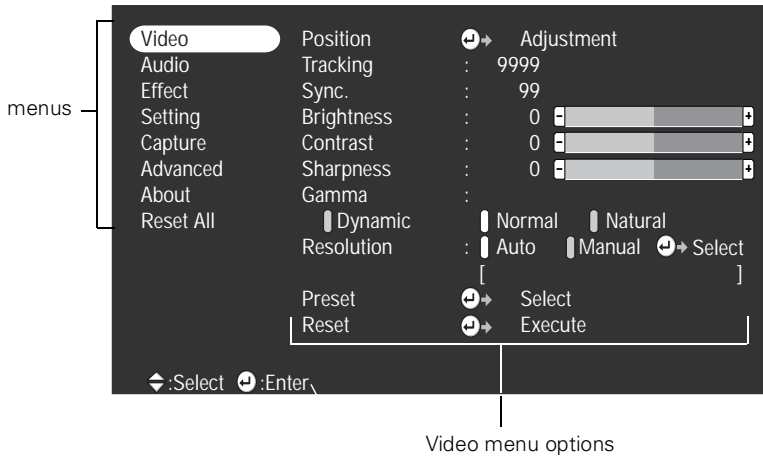

The eight menus are displayed at the left, and the options available for the Video menu (highlighted) are shown on the right.

2. Press the up or down arrows (control panel) or press up or down on the **Enter** button (remote control) to scroll through the menu choices.

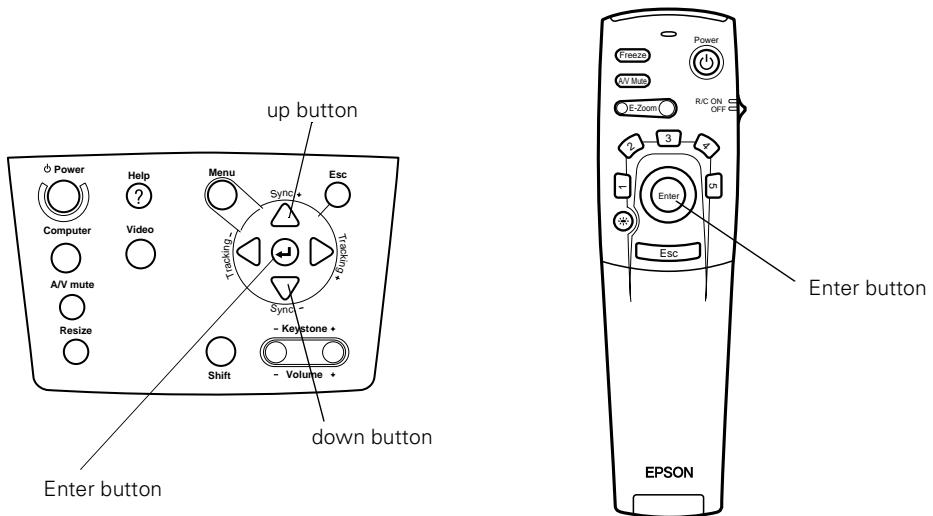

When you highlight a menu, its options are shown on the right.

**note**

*Some options are limited to being enabled (turned on) or disabled (turned off).*

*Enabled options are indicated by a green light.*

*Disabled options are blank.*

3. When the menu you want is highlighted, press the **Enter** button to select it.

The highlight moves to the first option for that menu.

4. Press the up or down arrows (control panel) or up or down on the **Enter** button (remote control) to scroll through the options.
5. Press either the left or right arrow buttons (control panel) or right or left on the **Enter** button (remote control) to change a setting on one of the submenus.
6. If you want to go back to the default settings on any menu, select **Reset**, press **Enter**, select **Yes**, and then press **Enter**.
7. Press the **Esc** button to go back to the main menu. Your changes are saved automatically.
8. Press the **Menu** button to exit the menu system.

The options available in each of the menus are described below.

# Adjusting the Image

The Video menu lets you make adjustments to the projected image. The options available in the menu depend on which source is connected to the projector: computer, composite (RCA) video, S-video, or BNC (component) video.

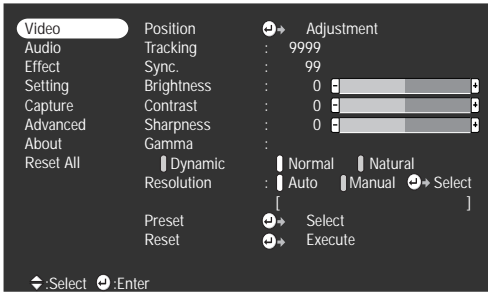

Video menu for Computer (D-sub 15/BNC)1 and 2



Video menu for Computer (DVI)

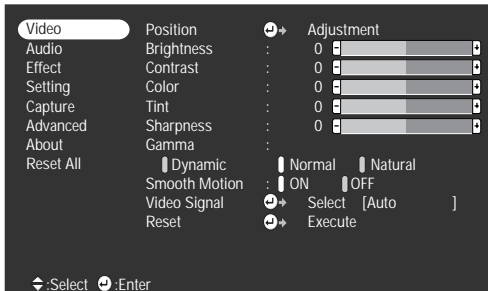

Video menu for composite video or S-Video

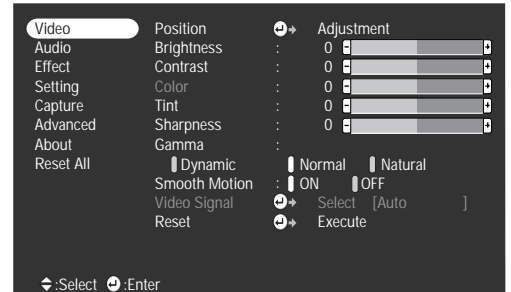

Video menu for BNC video

The following table describes all the possible options for the Video menu.

## Video Menu

Menu item	Description
Position	Moves the displayed image up, down, left, or right. Select this item and then press right on the <b>Enter</b> button (remote control) or press the right arrow button (control panel) to enter the screen position adjustment mode. Then use the <b>Enter</b> button (remote control) or up, down, left, and right buttons (control panel) to move the screen position in the corresponding direction. When you finish making adjustments, press the <b>Esc</b> button to return to the Video menu.
Tracking	Removes vertical lines from the computer image by matching the projector's internal clock to various computer graphic signals.
Sync	Corrects fuzziness or screen flicker by synchronizing the projector with the tracking signal sent from the computer.
Brightness	Lightens or darkens the overall image. Increase brightness to lighten an image, or decrease it to darken the image.
Contrast	Adjusts the difference between light and dark areas. Increase the contrast to make light areas lighter and dark areas darker. Decrease it to minimize the difference between light and dark areas.
Color	Adjusts the color depth of the image. Increase the color setting for more intense color on the screen, or lower the setting for less intense color.
Tint	Adjusts the tint of the image.
Sharpness	Adjusts the sharpness of the image.
Gamma	Adjusts the vividness of colors in the image. Choose <b>Dynamic</b> for an image with distinct color differences, such as charts. Choose <b>Normal</b> to leave tints uncorrected. Choose <b>Natural</b> to produce images with a natural tint, such as for video images.
Resolution	Specifies the input resolution. In most cases, this setting should be left at the <b>Auto</b> setting to allow the projector to automatically detect the video signal. If you want to specify a setting, however, select the <b>Manual</b> option and then choose from 32 settings.

Menu item	Description
Preset	Allows you to save and recall settings for up to five computer sessions including the resolution, tracking, sync signal, brightness, contrast, sharpness, gamma, and position. (See "Saving and Recalling Computer Settings" below.)
Smooth Motion	When turned <b>ON</b> , makes motion look smoother in images from non-DVD video sources.
Video Signal	Defines the video signal method. Select this item and then press the right arrow button (control panel) or right on the <b>Enter</b> button (remote control) to select the desired video signal method from the menu. If you select <b>Auto</b> the video signal will be selected automatically. Do not select <b>Auto</b> , however, if you are using a PAL (60 MHz) system.
Reset	Returns all menu items to their default settings. Select this item and then press the right arrow button (control panel) or right on the <b>Enter</b> button (remote control) to display the confirmation screen. Select <b>Yes</b> and then press <b>Enter</b> to reset the menu. If you change your mind, select <b>No</b> and then press <b>Enter</b> to clear the confirmation screen without changing any settings.

## ***Saving and Recalling Computer Settings***

When you are projecting from a computer source, you can save and recall settings (resolution, tracking, sync signal, and position) for up to five different sessions. This is useful if you use more than one computer with the projector; you can save the settings for each one and recall them when necessary. Follow these steps to save the current session settings:

### **note**

*If you want to overwrite an existing setting, move to the setting and press **Enter**.*

*When the confirmation message appears, choose **Yes** and press **Enter**.*

1. Press the **Menu** button on the control panel or remote control to display the Main menu.
2. Press **Enter** to select the Video menu.
3. Use the down arrow (control panel) or **Enter** button to move down to the **Preset** option and press **Enter**. You see the Preset Selection menu with the current resolution setting displayed.
4. Press **Enter** to assign it to the next available number.
5. Press **Enter** again. When you see the “Overwrite?” prompt, select **Yes** or **No** and press **Enter**.
6. Press **Esc** to return to the Video menu.

When you want to use a saved setting, press the **Preset** button on the remote control. You see the setting for session number 1 displayed in yellow at the top right of the screen. To select another number, press the **Preset** button again until the setting number you want is displayed. The projector will reset itself according to the selected setting.



## Adjusting the Sound

Use the Audio menu to adjust the sound volume and quality of your audio.

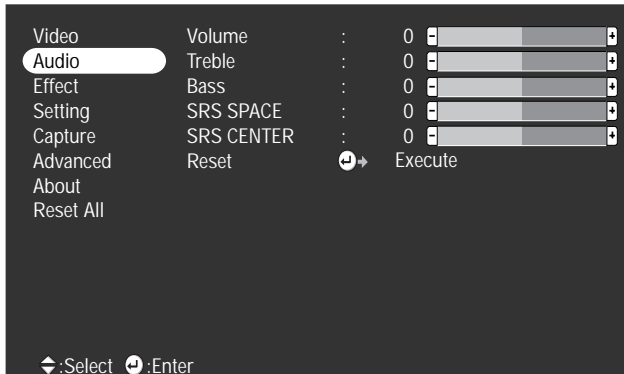

Menu item	Description
Volume	Adjusts the volume level for the speakers. Press the right arrow button (control panel) or press right on the <b>Enter</b> button (remote control) to increase the volume; press the left arrow button (control panel) or left on the <b>Enter</b> button (remote control) to decrease the volume.
Treble	Adjusts the treble (high) tone of the speakers.
Bass	Adjusts the bass (low) tone of the speakers.
SRS® SPACE	Adjusts the width of the sound.
SRS CENTER	Adjusts the depth of the sound.
Reset	Returns all Audio menu items to their initial factory defaults. Select this item and then press <b>Enter</b> to display the confirmation screen. Next, select <b>Yes</b> and press <b>Enter</b> to reset the Audio menu. If you change your mind, select <b>No</b> and press <b>Enter</b> to clear the confirmation screen without changing any settings.

## Customizing the Drawing Tools

The drawing tools let you highlight your presentation with cursor stamps, lines, boxes, and spotlights, as described on page 53. You can use the Effect menu to customize these tools and set the cursor speed for drawing. The **Reset** option lets you return all the drawing tools to their default settings.

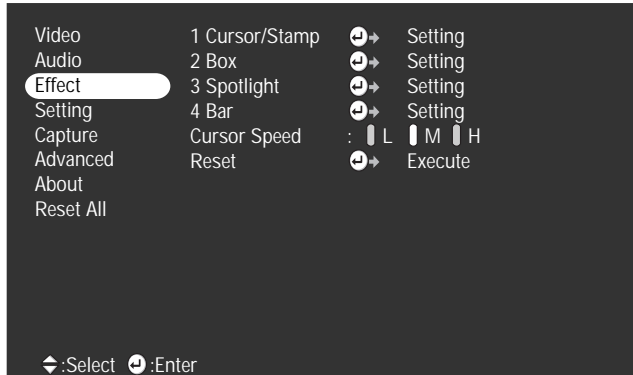

Menu item	Description
Cursor/Stamp	Sets the shape, size, color, and length of the cursor/stamp assigned to Effect button 1. You can define three different cursor/stamps and then select the desired one when you are giving your presentation by pressing Effect button 1 until the one you want is displayed. To change the cursor/stamp, select it from the Effect menu and then choose the desired attributes for each of the three stamps.
Box	Sets the color, fill characteristic and shape of the box tool assigned to Effect button 2. Select this option from the Effect menu and choose the desired box attributes.
Spotlight	Sets the size of the spotlight tool assigned to button 3. You can choose large, medium, or small.
Bar	Sets the color, direction, and width of the bar tool assigned to button 4. You can define three different bars and then select the desired one when you are giving your presentation by pressing Effect button 4 until the one you want is displayed. To change the bar, select it from the Effect menu and then choose the desired attributes for each of the three bars.

Menu item	Description
Cursor Speed	Adjusts the cursor speed to low, medium, or high.
Reset	Returns all Effect menu items to their initial factory defaults. Select this item and then press the <b>Enter</b> button to display the confirmation screen. Next, select <b>Yes</b> and then press the <b>Enter</b> button to reset the Effect menu. If you change your mind, select <b>No</b> and then press the <b>Enter</b> button to clear the confirmation screen without changing any settings.

## Customizing Projector Features

The Setting menu and the Advanced menu let you set or adjust many projector functions.

### Setting Menu

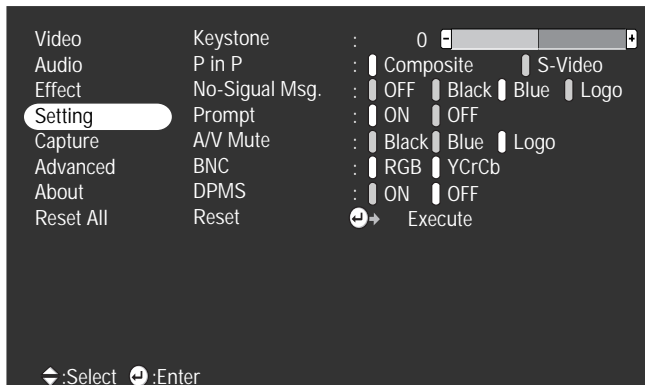

<b>Menu item</b>	<b>Description</b>
Keystone	Adjusts a trapezoid-distorted image to a 4:3 rectangle, correcting up to a $\pm 30^\circ$ tilt. See page 47.
P in P	Selects the image source for the P in P subscreen. See page 52 for more information.
No-Signal Msg	Specifies whether no screen, a black screen, a blue screen, or a user logo/image is displayed when no video signals are being received.
Prompt	Displays a temporary message (computer or video) identifying the image source when set to <b>ON</b> .
A/V Mute	Displays a blue, black, or user logo screen when the audio/video is turned off.
BNC	Specifies the format for BNC input. If the source is a computer, select <b>RGB</b> . If the source is a video device, select <b>YCrCb</b> .
Sleep mode	Enables or disables sleep mode. When sleep mode is on, the projector turns the lamp power off if the projector has not received any image signals from the input source for 30 minutes. Press the <b>Power</b> button to resume projecting.
Reset	Returns all Setting menu items to their default settings. Select this item and then press the <b>Enter</b> button to display the confirmation screen. Next, select <b>Yes</b> and press <b>Enter</b> to reset the Setting menu. If you change your mind, select <b>No</b> and press <b>Enter</b> to clear the confirmation screen without changing any settings.

## Advanced Menu

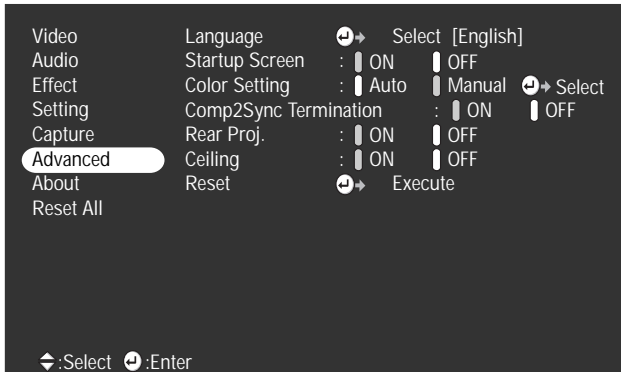

Menu item	Description
Language	Selects the language to be used in the menus: English, French, German, Italian, Spanish, Portuguese, Japanese, Chinese, or Korean.
Startup Screen	Turns on or off the display of your user logo during the projector's startup. The logo first must be captured and assigned, as described on page 72.
Color Setting	<p>Adjusts the color temperature of the image. Select <b>Auto</b> to let the projector automatically select the correct color temperature. Select <b>Manual</b> to set the values yourself, then press <b>Enter</b>.</p> <p><b>Absolute Color Temp</b> Select <b>Absolute Color Temp</b> or <b>RGB</b> and press <b>Enter</b>. Then adjust the screen color. Positive color temperature values provide a cold white; negative values provide a warmer white.</p> <p><b>Black Level</b> Press the right arrow button (control panel) or press right on the <b>Enter</b> button (remote control) to decrease black in the image.</p> <p><b>White Level</b> Press the left arrow button (control panel) or press left on the <b>Enter</b> button (remote control) to decrease white in the image.</p>
Comp2 Sync Termination	Normally set to <b>On</b> for the Computer 2 port to receive standard 75-ohm analog video signals. Can be set to <b>Off</b> to receive digital (TTL-level) video signals.

Menu item	Description
Rear Projection	Mirrors the projected image on its Y-axis (left-right). Selecting <b>ON</b> turns mirroring on, while <b>OFF</b> turns it off (for a normal image). Turn on this option when projecting from behind onto a transparent screen.
Ceiling	Mirrors the projected image on its X-axis (top-bottom). Selecting <b>ON</b> turns mirroring on, while <b>OFF</b> turns it off (for a normal image). Turn this option on when the projector is mounted upside-down from the ceiling.
Reset	Returns all Advanced menu items to their default settings. Select this item and then press <b>Enter</b> to display the confirmation screen. Next, select <b>Yes</b> and press <b>Enter</b> to reset the Advanced menu. If you change your mind, select <b>No</b> and press <b>Enter</b> to clear the confirmation screen without changing any settings.

## *Creating a Screen Logo or Image*

You can transfer any image on your computer to the projector, and then use it as the image displayed when the projector is not receiving a signal. You can also set it to be displayed when you press the **A/V Mute** button on the remote, or as a startup screen. The image can be a company logo, slogan, photograph, or any other image you want to use.

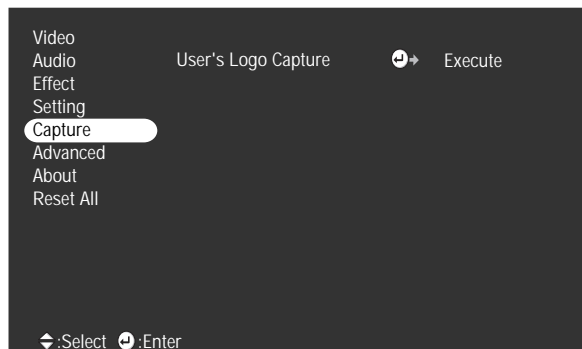

## ***Capturing and Saving the Image***

Follow these steps to capture and save a logo or image:

1. Display the image (with the projector).
2. Press the **Menu** button on the control panel or remote control to display the Main menu.
3. Press the down arrow (control panel) or press down on the **Enter** button (remote control) to move to the **Capture** menu.
4. Press **Enter** (control panel or remote control) to highlight the **User's Logo Capture** option and press **Enter** again to select it. You see the message "Do you use the present image as a user's logo?"
5. Select **Yes** and press **Enter**. A selection box appears over the image.
6. Use the arrow buttons on the control panel or the **Enter** button on the remote control to select the area of the image you want to use as the logo. Once you have selected the entire area, press **Enter**.
7. When the message "Do you use this image?" appears on the screen, select **Yes** and press **Enter**. If you want to change the area selected, select **No**, press **Enter** and repeat steps 4 through 6.
8. Use the arrow buttons on the control panel or the **Enter** button on the remote control to select a zoom rate, and then press **Enter**.
9. When the message "Do you save the user's logo?" appears, select **Yes** and press **Enter**. If you do not want to save the logo, select **No**.
10. When you see the message "Saving the user's logo is completed," press the **Menu** or **Enter** button to return to the Capture menu.
11. Press **Menu** or **Esc** to return to the Main menu.

---

### ***note***

*Saving the logo may take a few moments. Do not use the projector or other sources (computer, video, speaker, etc.) while the logo is being saved.*

---

## ***Assigning the Image to the No-Signal Message and/or A/V Mute Button***

After your image is saved, you can set it up as the no-signal message and/or the screen that's displayed when you press the A/V Mute button.

1. Press the **Menu** button on the control panel or remote control to display the Main menu (if not already displayed).
2. Select the **Setting** menu and then press the **Enter** button on the control panel or remote control.
3. Press the down arrow (control panel) or press down on the **Enter** button (remote control) to highlight **No-Signal Msg.**
4. Press the right arrow or use the **Enter** button to select **Logo**. This sets your image as the screen displayed when the projector is not receiving a signal.
5. If you want to set up your image as the A/V mute, use the down arrow or **Enter** button to move down to the **A/V Mute** option and select **Logo**.
6. Press **Esc** or the **Menu** button.

Now you can press the **A/V Mute** button on the control panel or the remote control to display the user logo or image. Press it again to turn off the logo.



## Viewing Projector Information

The About menu lets you view information about the display settings of your computer and the number of hours the lamp has been used. When the image source is a computer, the About menu displays the information listed below.

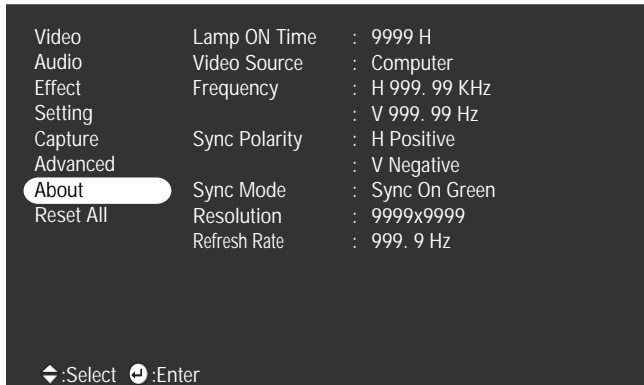

### **note**

*If you access the About menu when the image source is video, you see only the lamp life and the video signal setting.*

Menu item	Description
Lamp ON Time	Displays the number of hours the current lamp has been used.
Video Source	Displays the input source.
Frequency	Displays the projector's horizontal and vertical frequency.
Sync Polarity	Displays the horizontal and vertical sync polarity of the computer.
Sync Mode	Displays the sync mode of the computer.
Resolution	Displays the output resolution of the computer video output.
Refresh Rate	Displays the refresh rate of the computer video output.

## *Restoring the Default Settings*

The **Reset All** menu lets you return all the projector settings to their default values.

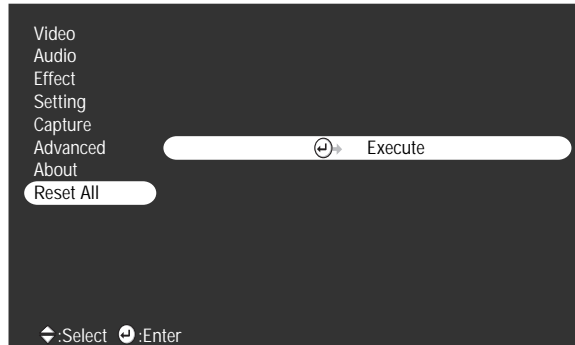

Select **Reset All** and press the **Enter** button on the control panel or remote control to display the confirmation screen. Select **Yes** to reset all the default settings or **No** to cancel.

# 4 *Maintaining and Transporting the Projector*

Your projector needs little maintenance. All you need to do on a regular basis is keep the lens clean. Any dirt or smears on the lens will show up on your projected image.

## **warning**

*Before you clean any part of the projector, turn it off and unplug the power cord. Never open any cover on the projector, except the lamp and filter covers. Dangerous electrical voltages in the projector can injure you severely. Do not try to service this product yourself, except as specifically explained in this User's Guide. Refer all other servicing to qualified service personnel.*

You also need to periodically clean the air filter on the bottom of the projector. A clogged air filter can block ventilation needed to cool the projector and keep it from overheating.

The only parts you should replace are the lamp and air filter. If any other part needs replacing, contact your dealer or a qualified service person.

This chapter covers the following:

- Cleaning the lens
- Cleaning the projector case
- Cleaning and replacing the air filter
- Replacing the lamp
- Transporting the projector

## *Cleaning the Lens*

Clean the lens whenever you notice dirt or dust on the surface.

- Lightly wipe the lens surface with a soft, dry, lint-free cloth.
- To remove dirt or smears on the lens, moisten a soft cloth with an alcohol-based cleaner and gently wipe the lens surface. Avoid touching any part of the projector case with any alcohol cleaner.

## *Cleaning the Projector Case*

Before you clean the case, first turn off the projector and unplug the power cord.

- To remove dirt or dust, wipe the case with a soft, dry, lint-free cloth.
- To remove stubborn dirt or stains, moisten a soft cloth with water and a neutral detergent. Then wipe the case.
- Do not use alcohol, benzene, thinner, or other chemical detergents. These can cause the case to warp.

## *Cleaning and Replacing the Air Filter*

Clean the air filter at the bottom of the projector after every 100 hours of use. If it is not cleaned periodically, it can become clogged with dust, preventing proper ventilation. This can cause overheating and damage the projector. To clean or replace the air filter, follow these steps:

1. Turn off the projector and unplug the power cable.
2. Turn the projector on its side so that the handle is on top and you can access the filter easily.
3. To clean the filter, EPSON recommends using a small vacuum cleaner designed for computers and other office equipment. If you don't have one, use a dry, lint-free cloth.

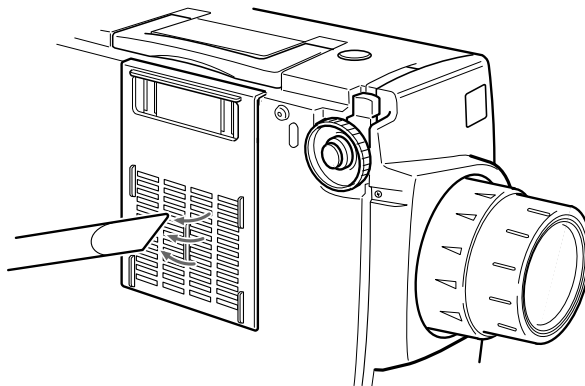

### **note**

*Standing the projector with the handle at the top prevents dust from getting inside the projector housing.*

If the dirt is difficult to remove or if the filter is torn, replace it. See page 92 for information on ordering accessories.

4. If you need to replace the filter, pull up on the tab to release the filter and remove it.

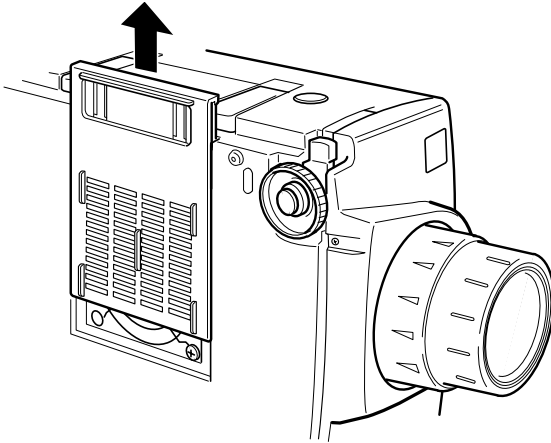

5. Insert the new filter as shown.

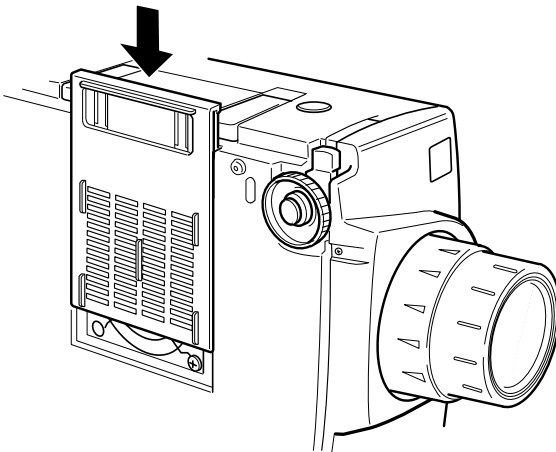

---

**note**

*When you get a replacement lamp for your projector, a new air filter is included. You should replace the filter when you replace the lamp.*

---

## Replacing the Lamp

### **note**

You can check to see how many hours the lamp has been used. See page 75.

The projection lamp typically lasts for about 2000 hours of use. It is time to replace the lamp when:

- The projection image gets darker or starts to deteriorate.
- The projection lamp light is flashing red or orange.
- The message **LAMP REPLACE** appears on the screen when the projector lamp comes on (after about 1900 hours of use). To maintain projector brightness and image quality, replace the lamp as soon as possible.

Contact your dealer or EPSON for a replacement lamp. (See page 92 for information on ordering accessories.) Request part number ELPLP11.

### **warning**

Let the lamp cool before replacing it. Also, do not touch the glass portion of the lamp assembly. Touching the glass will result in premature lamp failure.

1. Turn off the projector and unplug the power cable
2. Allow the projector to cool down for at least an hour (if it has been on).
3. Use a screwdriver to loosen the two retaining screws on the lamp cover. When the screws are loose, lift off the lamp cover. (You cannot remove these screws from the cover.)

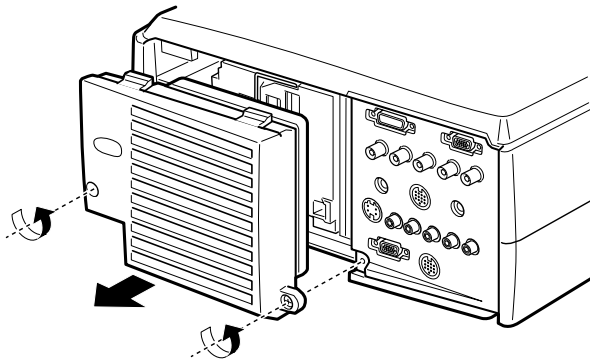

4. Use a screwdriver to loosen the three screws holding the lamp in place. (You cannot remove these screws.)

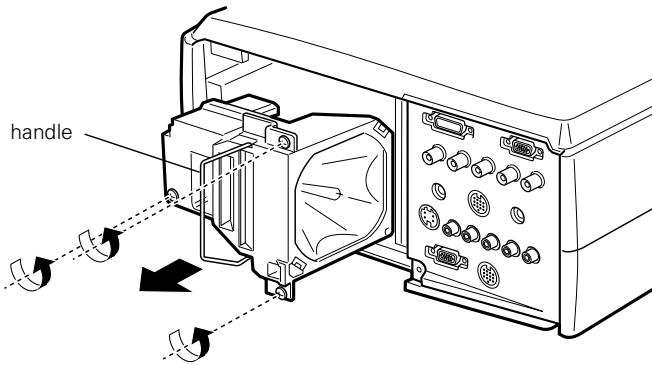

5. Lift up the handle and pull out the lamp.
6. Gently insert the new lamp as shown below. Make sure it's inserted securely.

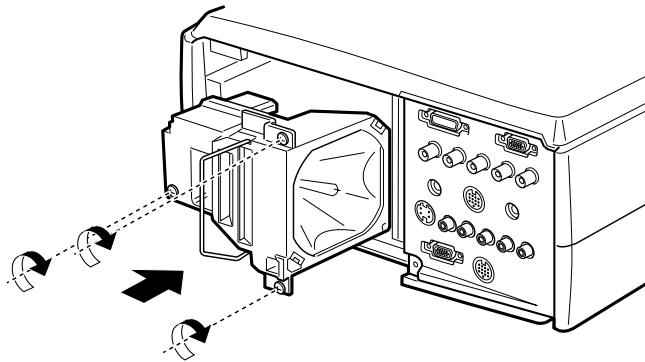

Tighten the screws on the new lamp.

7. Replace the lamp cover and tighten the cover screws. (Make sure the lamp cover is securely fastened. The projector won't turn on if the lamp cover is open.)
8. Now reset the lamp timer as described in the following section.

---

**caution**

*Do not touch the glass portion of the lamp assembly. Touching the glass will result in premature lamp failure.*

---

## ***Resetting the Lamp Timer***

After you install a new lamp, you need to reset the timer so the projector can keep track of how many hours it has been used. Follow these steps:

1. Press the **Help** button and hold it down for at least 5 seconds. The Help menu will be displayed and then you will see a menu asking if you want to reset the lamp ON time.
2. Use the left arrow button (control panel) or press left on the **Enter** button (remote control) to select **Yes**.
3. Press **Enter** to reset the timer.

## ***Transporting the Projector***

### **note**

*EPSON shall not be liable for any damages incurred during transportation.*

The projector contains many glass parts and precision parts. If you need to transport it, please follow these packing guidelines to prevent damaging the projector:

- When shipping the projector for repairs, use the original packaging material if possible. If you do not have the original packaging, use equivalent materials, placing plenty of cushioning around the projector.
- When transporting the projector as freight or checked luggage, first put it in a hard-shell carrying case (such as an optional EPSON accessory case), then pack it in a firm box, using cushioning around the case.
- When you are hand-carrying the projector, be sure to store it in a carrying case (such as the optional cases offered by EPSON).



# 5 *Solving Problems*

This chapter helps you diagnose and solve problems with your projector, and provides technical support information for problems you can't solve yourself. You can also check the on-screen help by pressing the **? Help** button on the control panel or remote control. See page 57 for instructions on using the help system.

This chapter explains the following:

- Problems with the projector. See this section if the projector is not working and to find out what the warning lights mean.
- Problems with the remote control. See this section if the projector is not responding to remote control commands.
- Problems with the screen image or sound. See this section if you cannot project an image or if the screen image is not good.

If none of the suggestions solves the problem, see “Where To Get Help” on page 92.

## Problems with the Projector

If the projector is not working correctly, first turn it off and unplug it. Then plug the power cord back in and turn on the projector. If this does not solve the problem, check the warning lights on top of the projector. These lights alert you to problems with projector operation.

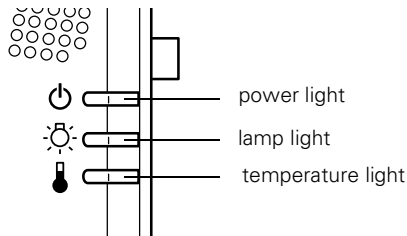

### Projector status and warning lights

Light	Status	Description and action
	orange	The projector is in sleep mode. You can unplug it to turn it off or press the <b>Power</b> button to turn it on.
	flashing green	The projector is warming up. Wait for the image to appear.
	green	The projector is operating normally.
	flashing orange	The projector lamp is off and the projector is cooling down. You can't turn the projector on or unplug it when the light is flashing.
	red	Power is cut off because of an internal problem. Contact EPSON.
	flashing orange	The lamp is almost burned out. This is a good time to replace it. See Chapter 4 for instructions.
	flashing red	The lamp is burned out or there is a problem with the lamp power. Replace it as described in Chapter 4. If replacing the lamp does not solve the problem, contact EPSON.
	flashing orange	The projector is too hot. Turn it off and let it cool before using it.
	red	The projector has overheated. Let it cool for a few minutes, then turn it back on. See Chapter 4.
	flashing red	There is a problem with the cooling fan or temperature sensor. Contact EPSON for help.

See the information below for what to do when you see these warning lights or encounter other specific problems with the projector.

**The  power light is flashing orange and you cannot turn on the projector.**

The lamp is cooling down. Wait until the light turns off and then press the **Power** button to turn on the projector.

**The  power light does not come on.**

Press the **Power** button to turn off the projector, check that the power cable is connected securely both at the power outlet and the projector, and press the **Power** button again. Try removing and reseating the lamp.

**Projected images get darker or start to deteriorate, or the  lamp warning light is flashing red.**

Replace the lamp as described in Chapter 4.

**The  temperature light is red.**

- The projector is overheating, which turns the lamp off automatically. Let the projector cool for a few minutes, then turn it back on. Make sure there is plenty of space around and under the projector for ventilation. If it continues to overheat, you may need to change the air filter.
- The air filter may be clogged. Clean it as described in Chapter 4 and then let the projector cool for awhile. If this does not work, you may need to change the air filter. See Chapter 4.
- If the projector continues to overheat after you clean the air filter, the problem may be caused by damage to the cooling fan or internal circuits. Contact EPSON for help.

**The  temperature light is flashing orange.**

The projector is too hot. Press the **Power** button to turn it off and let it cool for 5 minutes before using it again.

---

**warning**

*Except as specifically explained in this User's Guide, do not attempt to service this product yourself.*

---

## *Problems with the Remote Control*

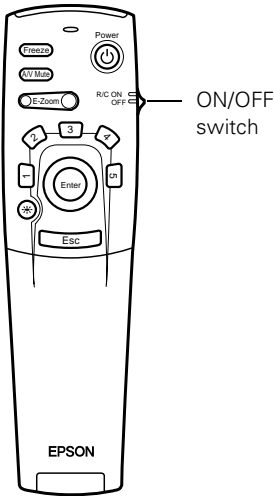

### **The projector doesn't respond to remote control commands.**

- Make sure the remote control is turned on.
- Make sure you are within 30 feet of the projector, and within range of the infrared receivers (approximately 30° to left or right and 15° above or below).
- The remote control batteries may not be installed correctly or may be low on power. Check the installation or replace them as described on page 12.
- Dim the room lights and turn off any fluorescents. Make sure the projector is not in direct sunlight. Strong lighting, especially fluorescent lights, may affect the projector's infrared receivers.
- Turn off any nearby equipment that emits infrared energy, such as a radiant room heater.

### **You can't control the mouse pointer with the remote control.**

- Make sure the mouse cable is securely connected to both your computer's mouse port (using the main cable) and the projector's mouse port. See Chapter 1 for details.
- Make sure you have used the correct cable. The PS/2 mouse cable and Macintosh mouse cable look the same, but they are not identical. Check the label on the end of the cable.

## *Problems with the Image or Sound*

### **No image appears on the screen.**

- Check that the power light is green, not flashing, and the lens cover is off.
- The projector may be in sleep mode. If the power light is orange, press the **Power** button to turn the projector on.
- If the power was switched off and then on again, the projector may still be cooling down. Wait until the power light stops flashing and remains orange; then press the **Power** button again.
- Make sure the **Brightness** setting on the Video menu is correct. See page 64 for more information. Try selecting the **Reset All** setting to return all setup menus to their default values.
- Press the **A/V Mute** button to make sure the picture has not been turned off temporarily.
- The attached computer may be in sleep mode or displaying a black screen saver. Try pressing a key on the computer.

### **You see a blue screen with the message No Signal displayed.**

- Make sure the cables are connected correctly, as described in Chapter 1.
- Try restarting your computer.
- If you've connected more than one computer and/or video source, you may need to press the **Computer** or **Video** button (on the control panel) or the **Comp1**, **Comp2/YCbCr**, or **Video** button (on the remote control) to select the correct source. Allow a few seconds for the projector to sync up after pressing the button.
- If you've connected a second computer or you're using component video, make sure the **BNC** option in the Setting menu is correct. See page 69 for more information.
- Make sure the **Computer 1/DVI** selector switch on the projector's interface panel is set correctly. See Chapter 1.

### If you're using a PC laptop:

- Press the function key that lets you display on an external monitor. It's often labelled with an icon such as  but it may also be labelled CRT/LCD. You may have to hold down the Fn key while pressing it. Check your laptop's manual or online help for details.

On most systems, the  or CRT/LCD key lets you toggle between the LCD screen and the projector, or to display on both at the same time. Allow a few seconds for the projector to sync up after pressing it.

- Depending on your computer's video card, you might need to use the Display utility in the Control Panel to make sure that both the LCD screen and external monitor port are enabled. See your computer's documentation or online help for details.

### If you're using a PowerBook:

1. From the Apple menu, select **Control Panels**, then click **Monitors and Sound**.
2. Click the **Arrange** icon.
3. Drag one monitor icon on top of the other. This lets you display on the projector screen as well as the LCD screen.
4. If this option isn't available, click the **Monitor** icon.
5. Select one of the listed **Simulscan** resolutions. (Allow a few seconds for the projector to sync up after making the selection.)

### The message **Not Supported is displayed.**

Make sure your computer's resolution doesn't exceed UXGA (1600 × 1200), and the frequency is supported by the projector (see page 95). If necessary, change your computer's resolution setting as described below.

### **Only part of the computer image is displayed.**

- Press the **Resize** button on the control panel or remote control.
- Make sure the image **Position** setting is correct on the Video menu. See page 64 for more information.
- If the right or left side of the image is cut off, you may need to adjust the tracking using the buttons on the control panel. Hold down the + or – **Tracking** button to change the setting until the image looks correct.
- Make sure your computer's resolution setting is correct. Ideally, it should be 1024 × 768 (PowerLite 8100i) or 1280 × 1024 (PowerLite 9100i) to match the projector's native resolution. If this option isn't available, select one of the other compatible video formats listed on page 95.
  - **Windows:**  
Right-click the desktop, select **Properties**, click the **Settings** tab, and use the dialog box to select a different resolution.
  - **Macintosh:**  
On the Apple menu, choose **Control Panels**, then click **Monitors and Sound**. Select a different resolution.
- You also may need to modify existing presentation files if you created them for a different resolution. See your software manual for specific information.

### **The image has a distorted, crooked, or keystone (trapezoid) shape.**

- This may be caused by extending the legs and tilting the projector to position the image. Press the right + or left – side of the **Keystone** button on top of the projector. Press and hold either side of the button until the image is rectangular.
- Make sure the projector faces the screen squarely. If the projector is not pointed straight at the screen, your image will be distorted.

### **The image or parts of the image are blurred or not in focus.**

- Adjust the focus using the focus ring.
- Adjust the Brightness, Contrast, Sharpness, and Gamma settings on the Video menu. If you're viewing a computer image, also try adjusting the Tracking and Sync buttons on the projector's control panel.

When you change video settings, you should be able to see the effect on the screen immediately. If you don't like the new settings, you can always select **Reset** to return to the factory default settings.

- Try pressing the **Auto** button on the remote control or the **Enter** button on the control panel to automatically reset the video settings.
- There may be dirt or smears on the lens. Clean the lens as described on page 77.

### **The image vibrates, flickers, or has vertical lines.**

If you're projecting from a computer, try pressing **Auto** on the remote control or **Enter** on the control panel. This resets the computer display settings automatically.

#### **note**

*Images will be projected more vividly if you adjust the Tracking before the Sync.*

If that doesn't work, adjust the Tracking and Sync using the buttons on the control panel. Hold down the button to change the setting until your image looks correct. It is best to project a gray screen (or the screen you see when you exit Windows) when you adjust these settings.

You can also change the Tracking and Sync settings through the Video menu (see page 64).

### **The image quality is poor on a laptop computer.**



The video signal may be split between the computer and the projector. If you notice a decline in the projected image quality when the image is displayed simultaneously on your laptop computer and the projector, turn off the laptop LCD display.



### **The colors of the image are not right.**

- The color balance may be incorrect. If you're displaying a computer image, use the Gamma option in the projector's Video menu to adjust the balance of red, green, and blue. If you're displaying video, adjust the Color, Tint, and Gamma settings on the Video menu. Also try adjusting the Color Setting option in the Advanced menu.
- Check your computer display settings to correct the color balance.

### **There is no sound.**

- First check that the volume is not turned all the way down and that the audio cable is securely attached to both the projector and the audio source.
- Make sure the **A/V Mute** button is not enabled.
- If you're using a VCR or other video source, make sure the volume is not turned all the way down. Also, make sure the cables are connected correctly, as described in Chapter 1.
- If your presentation includes computer audio, make sure the volume control on your computer is not turned all the way down. Make sure the audio cable is securely connected to both the projector and your computer's  headphone jack or  audio out jack. See Chapter 1 for more information.
- Make sure the volume controls on your computer are not turned all the way down or set to Mute.
- The wrong source may be selected. Press the **Computer** or **Video** button on the control panel—or the **Comp1**, **Comp2/YCbCr** or **Video** button on the remote control—to select the proper source.

## Where To Get Help

EPSON provides technical assistance through electronic support services and automated telephone services 24 hours a day, as listed in the following table:

Service	Access
World Wide Web Technical Support	From the Internet, you can reach EPSON's product support page at <a href="http://support.epson.com">http://support.epson.com</a> . After selecting your product, you can view frequently asked questions and answers, download product documentation, and receive technical advice through e-mail.
Automated Telephone Services	A variety of automated help services are available 24 hours a day, seven days a week. To use these services, you must have a touch tone telephone and call <b>(800) 922-8911</b> .
Presenters Online	Access tips, templates, and training for developing successful presentations at <a href="http://www.presentersonline.com">http://www.presentersonline.com</a>

### Telephone Support Services

To use the EPSON PrivateLine Support service, call (800) 637-7661 and enter the PIN on the EPSON PrivateLine Support card included in your *Owner's Kit*. This is the fastest way to speak to a live representative, and it's free. This service is available 6 AM to 6 PM, Pacific Time, Monday through Friday, for the duration of your warranty period.

#### **note**

*You can purchase screens, carrying cases, or other accessories from EPSON by calling (800) 873-7766; in Canada, please call (800) 873-7766 for dealer referral. To purchase accessories online or view EPSON's complete product catalog, visit the EPSON Store at [www.epsonstore.com](http://www.epsonstore.com) (U.S. sales only). To see our full line of multimedia projectors, go to [www.epson.com/mul\\_proj](http://www.epson.com/mul_proj).*

You may also speak to a projector support specialist by dialing one of these numbers (toll or long distance charges may apply):

- U.S.: (562) 276-4394, 6 AM to 6 PM, Pacific Time, Monday through Friday
- Canada: (905) 709-3839, 6 AM to 6 PM, Pacific Time, Monday through Friday

Before you call, please have the following information ready:

- Product name (EPSON PowerLite 8100i or 9100i)
- Product serial number (located on the bottom of the projector)
- Video source (computer, DVD player, etc.) and how it's connected
- Description of the problem

# 6 *Technical Specifications*

## **General**

Type of display	Poly-silicon Thin Film Transistor (TFT)
Size of liquid crystal panels	Diagonal: 1.3 inches (34 mm)
Lens	PowerLite 8100i: F=1.7–2.3, f=49–63 mm PowerLite 9100i: F=1.8–2.4, f=49–69 mm
Resolution	PowerLite 8100i: 1024 × 768 pixels PowerLite 9100i: 1280 × 1024 pixels
Color reproduction	24 bit, 16.7 million colors
Brightness	PowerLite 8100i: 3200 lumens (ANSI) PowerLite 9100i: 2400 lumens (ANSI)
Contrast ratio	PowerLite 8100i: 400 : 1 PowerLite 9100i: 300 : 1
Image size	PowerLite 8100i: Wide angle: 28 to 300 inches (at 3.3 to 37.3 feet distance) Tele angle: 21 to 300 inches (at 3.1 to 48.1 feet distance)  PowerLite 9100i: Wide angle: 30 to 320 inches (at 3.6 to 36.7 feet distance) Tele angle: 20 to 300 inches (at 4.6 to 51.8 feet distance)
Projection distance	PowerLite 8100i: 3.1 to 48.1 feet (0.9 to 14.6 meters) PowerLite 9100i: 3.6 to 51.8 feet (1.1 to 15.8 meters)
Projection methods	Front, rear, upside-down (ceiling mount)

Internal speaker system	2 × 3 W 8 (ohm) speakers
Optical aspect ratio	4:3 (horizontal : vertical)
Zoom ratio	PowerLite 8100i: 1:1.3 PowerLite 9100i: 1:1.4
Manual lens shift	0 to 10 degrees
Keystone correction angle	± 30° (ratio: 10.0 to 5.5)

### ***Projection Lamp***

Type	UHE (Ultra High Efficiency)
Power consumption	230 W
Lamp life	About 2000 hours
Part number	ELPLP11

### ***Remote Control***

Range	32.8 feet (10 meters)
Batteries	Alkaline AA (2)

### ***Mouse Compatibility***

Supports PS/2, USB, serial, ADB

### ***Remote IR Receiver***

Supports EPSON Remote IR Receiver, 10-foot cable (typical use for rear screen projection)

### ***Dimensions***

Height	6.1 inches (157 mm)
Width	12 inches (305 mm)
Depth	18.7 inches (475 mm)
Weight	18.3 lb (8.3 kg)

## **Electrical**

Rated frequency	50/60 Hz
Power supply	100 to 120 VAC, 4.0 A 200 to 240 VAC, 2.0 A
Power consumption	Operating: 360 W Standby: 8.5 W

## **Environmental**

Temperature	Operating: 41 to 104° F (5 to 40° C), non-condensing Storage: 14 to 140° F (-10 to 60° C), non-condensing
Humidity	Operating: 20 to 80% RH, non-condensing Storage: 10 to 90% RH, non-condensing

## **Safety**

United States	FCC Part 15B Class B UL1950 Rev. 3
Canada	DOC SOR/88-475 CSA C22.2 No. 950 Rev. 3
CE Marking	Directive 89/336/EEC EN 55022 Class B EN 50082-1 Directive 73/23/EEC EN 60950

## **Compatible Video Formats**

The projector supports the following international video standards: NTSC, NTSC 4.43, PAL, PAL 60, PAL-M, PAL-N, and SECAM. In addition, the projector supports the computer monitor display formats listed below. To project images output from a computer, the computer's video card must be set at a refresh rate (vertical frequency) that's compatible with the projector; see the following table.

### **note**

*The frequencies of some computers may not allow images to be displayed correctly; see your computer's documentation for details.*

Mode	Resolution	Frequency			PowerLite 8100i	PowerLite 9100i
		H (KHz)	V (Hz)	Pixel (MHz)		
PC (RGB) compatible modes						
VGACGA	640 x 400	31.46	70	25.175	1024 x 640 **	1366 x 854 **
VGAEGA	640 x 350	31.46	70	25.175	1024 x 560 **	1366 x 748 **
NEC400	640 x 400	24.83	56.65	21.053	1024 x 640 **	1366 x 854 **
VGA60	640 x 480	31.469	59.94	25.175	1024 x 768 **	1366 x 1024 **
VGA72	640 x 480	37.861	72.809	31.5	1024 x 768 **	1366 x 1024 **
VGA75	640 x 480	37.5	75	31.5	1024 x 768 **	1366 x 1024 **
VGA85	640 x 480	48.269	85.008	36	1024 x 768 **	1366 x 1024 **
VGA100	640 x 480	51	100	42.5	1024 x 768 **	1366 x 1024 **
VGA120	640 x 480	61	120	50.8	1024 x 768 **	1366 x 1024 **
SVGA56	800 x 600	35.156	56.25	36	1024 x 768 **	1366 x 1024 **
SVGA60	800 x 600	37.879	60.317	40	1024 x 768 **	1366 x 1024 **
SVGA72	800 x 600	48.077	72.188	50	1024 x 768 **	1366 x 1024 **
SVGA75	800 x 600	46.875	75	49.5	1024 x 768 **	1366 x 1024 **
SVGA85	800 x 600	53.674	85.061	56.25	1024 x 768 **	1366 x 1024 **
SVGA100	800 x 600	63	100	67	1024 x 768 **	1366 x 1024 **
SVGA120	800 x 600	76	120	80	1024 x 768 **	1366 x 1024 **
XGA43i	1024 x 768	35.522	86.958	44.9	1024 x 768	1366 x 1024 **
XGA60	1024 x 768	48.363	60.004	65	1024 x 768	1366 x 1024 **
XGA70	1024 x 768	56.476	70.069	75	1024 x 768	1366 x 1024 **
XGA75	1024 x 768	60.023	75.029	78.75	1024 x 768	1366 x 1024 **
XGA85	1024 x 768	68.677	84.997	94.5	1024 x 768	1366 x 1024 **
XGA100	1024 x 768	81	100	111	1024 x 768	1366 x 1024 **
XGA120	1024 x 768	97	120	133	1024 x 768	1366 x 1024 **
SXGA1-70	1152 x 864	63.851	70.012	94.5	1024 x 768 *	1366 x 1024 **
SXGA1-75	1152 x 864	67.5	75	108	1024 x 768 *	1366 x 1024 **
SXGA1-85	1152 x 864	77.094	84.999	121.5	1024 x 768 *	1366 x 1024 **
SXGA1-100	1152 x 864	90	100	144	1024 x 768 *	1366 x 1024 **
SXGA2-60	1280 x 960	60	60	108	1024 x 768 *	1366 x 1024 **
SXGA2-75	1280 x 960	75	75	126	1024 x 768 *	1366 x 1024 **
SXGA2-85	1280 x 960	85.938	85.002	148.5	1024 x 768 *	1366 x 1024 **
SXGA3-43i	1280 x 1024	46.433	86.871	78.75	960 x 768 *	1280 x 1024
SXGA3-60	1280 x 1024	63.981	60.02	108	960 x 768 *	1280 x 1024
SXGA3-75	1280 x 1024	79.976	75.025	135	960 x 768 *	1280 x 1024
SXGA3-85	1280 x 1024	91.146	85.024	157.5	960 x 768 *	1280 x 1024

Mode	Resolution	Frequency			PowerLite 8100i	PowerLite 9100i
		H (KHz)	V (Hz)	Pixel (MHz)		
UXGA48i	1600 x 1200	62.5	96.08	135	1024 x 768 *	1366 x 1024 *
UXGA60	1600 x 1200	75	60	162	1024 x 768 *	1366 x 1024 *
UXGA65	1600 x 1200	81.25	65	175.5	1024 x 768 *	1366 x 1024 *
UXGA70	1600 x 1200	87.5	70	189	1024 x 768 *	1366 x 1024 *
UXGA75	1600 x 1200	93.75	75	202.5	1024 x 768 *	1366 x 1024 *
UXGA80	1600 x 1200	100	80	202.5	1024 x 768 *	1366 x 1024 *
UXGA85	1600 x 1200	106.25	85	202.5	1024 x 768 *	1366 x 1024 *
MACLC 13	640 x 480	34.975	66.62	31.33	1024 x 768 **	1366 x 1024 **
MAC II 13	640 x 480	35	66.67	30.24	1024 x 768 **	1366 x 1024 **
iMAC VGA	640 x 480	60.49	117	50.39	1024 x 768 **	1366 x 1024 **
iMAC SVGA	800 x 600	60.33	95	62.62	1024 x 768 **	1366 x 1024 **
MAC16	832 x 624	49.725	74.55	57.28	1024 x 768 **	1366 x 1024 **
MAC19-60	1024 x 768	48.193	59.28	64	1024 x 768	1366 x 1024 **
MAC19-75	1024 x 768	60.241	74.93	80	1024 x 768	1366 x 1024 **
iMAC XGA	1024 x 768	60	75	78.7	1024 x 768	1366 x 1024 **
MAC21	1152 x 870	68.682	75.062	100	1016 x 768 *	1356 x 1024 **
PC (YUV) compatible modes						
HDTV480P	720 x 483	31.469	59.94	27	1024 x 768 *	1366 x 1024 *
HDTV480i	720 x 487	15.734	59.94	13.5	1024 x 768 *	1366 x 1024 *
HDTV720P***	1280 x 720	44.955	59.94	74.176	1024 x 576 *	1366 x 768 *
HDTV1080P ***	1920 x 1080	67.433	59.94	148.352	1024 x 576 *	1366 x 768 *
HDTV1080i ***	1920 x 1080	33.716	59.94	74.176	1024 x 576 *	1366 x 768 *
Video compatible modes						
NTSC (SXGA) ***	1366 x 438	15.734	60	28.486	—	1366 x 1024 *
NTSC (XGA) ***	1024 x 435	15.734	60	20.89	1024 x 768 *	—
PAL (SXGA) ***	1366 x 512	15.625	50	28.846	—	1366 x 1024 *
PAL (XGA) ***	1024 x 512	15.625	50	21.154	1024 x 768 *	—
SECAM (SXGA) ***	1366 x 512	15.625	50	28.846	—	1366 x 1024 *
SECAM (XGA) ***	1024 x 512	15.625	50	21.154	1024 x 768 *	—

\* Resize mode (those without asterisks are native mode).

\*\* Although resize mode is shown, Windows mode is also available.

\*\*\*Select 4:3 or 16:9 mode as the Aspect Ratio setting in the Video menu; see page 64 for instructions.

# Interface Connectors

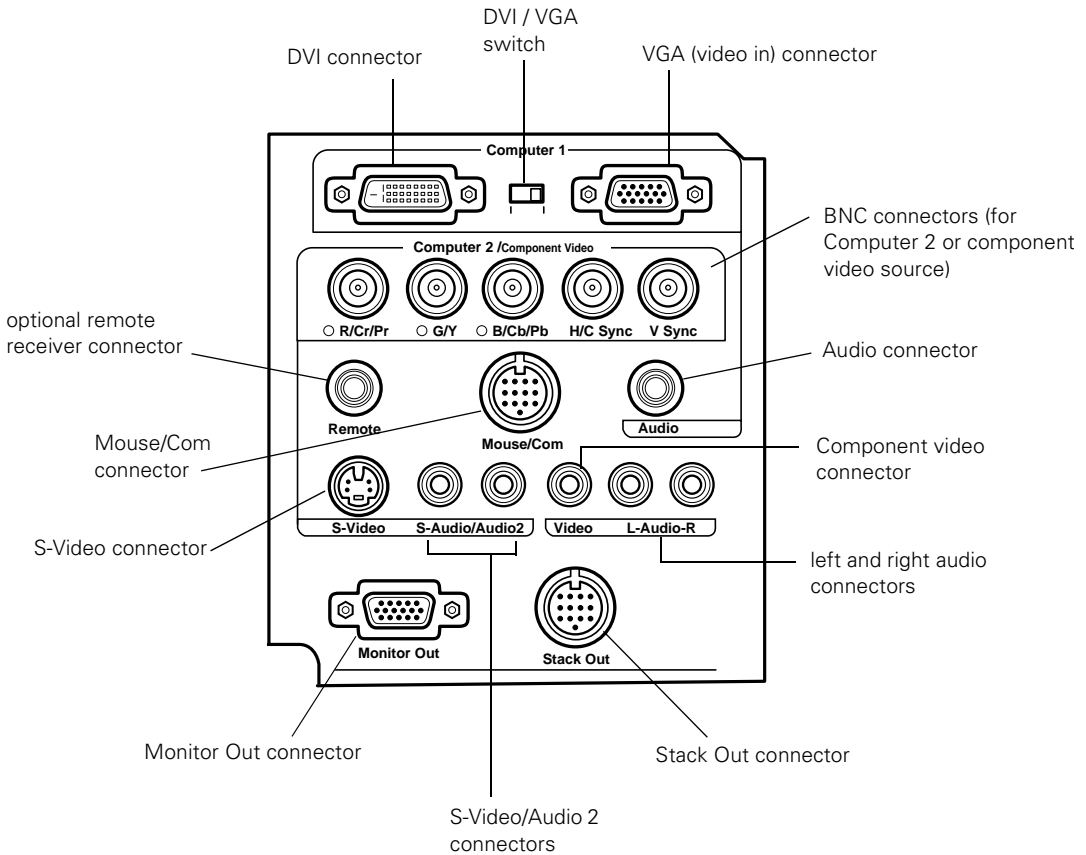



## **Computer Video Port Pin Assignments**

The Computer 1 analog port (the VGA port on the right side of the projector) and the Monitor Out port are female video RGB, 15-pin micro-D-style connectors. Here are their pin assignments:

<b>Pin no.</b>	<b>Computer 1 port</b>	<b>Monitor Out port</b>
1	Red video	Red out / red video
2	Green video	Green out / green video
3	Blue video	Blue out / blue video
4	Monitor (ID bit 2)	Reserved
5	GND	GND
6	Red video GND	GND
7	Green video GND	GND
8	Blue video GND	GND
9	+5 V	Reserved
10	Synchronous GND	GND
11	Monitor (ID bit 0)	Reserved
12	SDA	Reserved
13	Horizontal sync	Horizontal sync
14	Vertical sync	Vertical sync
15	Reserved	Vertical sync

## **note**

*The formulas given here are for when the projector is placed flat, without tilting it up at the screen (see page 14). If you tilt it up by extending the feet or use electronic keystone correction, your image size may vary.*

---

## **Image Size and Projection Distance**

Use the formulas given below either to find out how large your image will be when you know the distance from the projector to the screen, or to find out how far from the screen to place the projector if you want an image of a certain size. Since the size of the image can be changed by rotating the zoom ring, formulas are given for calculating both the minimum and maximum sizes.

### **Standard Lens**

To determine the diagonal size of an image when you know the projection distance:

#### ■ **Inches:**

Maximum diagonal size =  $(0.6676 \times \text{projection distance}) + 1.8$

Minimum diagonal size =  $(0.5173 \times \text{projection distance}) + 1.4$

#### ■ **Centimeters :**

Maximum diagonal size =  $(0.6676 \times \text{projection distance}) + 4.6$

Minimum diagonal size =  $(0.5173 \times \text{projection distance}) + 3.6$

To determine the projection distance when you know the diagonal size of the screen image:

#### ■ **Inches:**

Maximum projection distance =  $(1.498 \times \text{diagonal size}) - 2.7$

Minimum projection distance =  $(1.933 \times \text{diagonal size}) - 2.7$

#### ■ **Centimeters:**

Maximum projection distance =  $(1.498 \times \text{diagonal size}) - 6.9$

Minimum projection distance =  $(1.933 \times \text{diagonal size}) - 6.9$

### **Long Throw Zoom Lens (ELPLL02)**

To determine the diagonal size of an image when you know the projection distance:

#### ■ **Inches:**

Maximum diagonal size =  $(0.487 \times \text{projection distance}) + 2.3$

Minimum diagonal size =  $(0.286 \times \text{projection distance}) + 1.5$

#### ■ **Centimeters:**

Maximum diagonal size =  $(0.487 \times \text{projection distance}) + 5.9$

Minimum diagonal size =  $(0.286 \times \text{projection distance}) + 3.7$

To determine the projection distance when you know the diagonal size of the screen image:

■ **Inches:**

Maximum projection distance =  $(3.492 \times \text{diagonal size}) - 5.1$

Minimum projection distance =  $(2.053 \times \text{diagonal size}) - 4.8$

■ **Centimeters:**

Maximum projection distance =  $(3.492 \times \text{diagonal size}) - 12.9$

Minimum projection distance =  $(2.053 \times \text{diagonal size}) - 12.2$

### *Extra Long Throw Zoom Lens (ELPLL03)*

To determine the diagonal size of an image when you know the projection distance:

■ **Inches:**

Maximum diagonal size =  $(0.231 \times \text{projection distance}) + 2.2$

Minimum diagonal size =  $(0.171 \times \text{projection distance}) + 1.7$

■ **Centimeters:**

Maximum diagonal size =  $(0.231 \times \text{projection distance}) + 5.7$

Minimum diagonal size =  $(0.171 \times \text{projection distance}) + 4.2$

To determine the projection distance when you know the diagonal size of the screen image:

■ **Inches:**

Maximum projection distance =  $(4.331 \times \text{diagonal size}) - 9.7$

Minimum projection distance =  $(5.850 \times \text{diagonal size}) - 9.7$

■ **Centimeters:**

Maximum projection distance =  $(4.331 \times \text{diagonal size}) - 24.6$

Minimum projection distance =  $(5.850 \times \text{diagonal size}) - 24.6$

### ***Short Throw Zoom Lens (ELPLW01)***

To determine the diagonal size of an image when you know the projection distance:

■ **Inches:**

$$\text{Maximum diagonal size} = (0.876 \times \text{projection distance}) + 3.8$$

$$\text{Minimum diagonal size} = (0.730 \times \text{projection distance}) + 3.0$$

■ **Centimeters:**

$$\text{Maximum diagonal size} = (0.876 \times \text{projection distance}) + 9.6$$

$$\text{Minimum diagonal size} = (0.730 \times \text{projection distance}) + 7.7$$

To determine the projection distance when you know the diagonal size of the screen image:

■ **Inches:**

$$\text{Maximum projection distance} = (1.369 \times \text{diagonal size}) - 4.1$$

$$\text{Minimum projection distance} = (1.142 \times \text{diagonal size}) - 4.3$$

■ **Centimeters:**

$$\text{Maximum projection distance} = (1.369 \times \text{diagonal size}) - 10.5$$

$$\text{Minimum projection distance} = (1.142 \times \text{diagonal size}) - 11.0$$

### ***Fixed Short Throw Lens (ELPLR01)***

To determine the diagonal size of an image when you know the projection distance:

■ **Inches:**

$$\text{Diagonal size} = (1.239 \times \text{projection distance}) + 3.4$$

■ **Centimeters:**

$$\text{Diagonal size} = (1.239 \times \text{projection distance}) + 8.7$$

To determine the projection distance when you know the diagonal size of the screen image:

■ **Inches:**

$$\text{Projection distance} = (0.807 \times \text{diagonal size}) - 2.8$$

■ **Centimeters:**

$$\text{Projection distance} = (0.807 \times \text{diagonal size}) - 7.0$$

# 7

## Notices

This chapter includes safety instructions and other important information about your EPSON PowerLite projector.

### *Important Safety Instructions*

Follow these safety instructions when setting up and using the projector:

- Do not place the projector on an unstable cart, stand, or table.
- Do not use the projector near water or sources of heat.
- Use attachments only as recommended.
- Use the type of power source indicated on the projector. If you are not sure of the power available, consult your dealer or power company.
- Place the projector near a wall outlet where the plug can be easily unplugged.

*Placez le projecteur près d'une prise de contact où la fiche peut être débranchée facilement.*

- Insert the projector's three-wire grounding-type plug into a properly grounded outlet. If you have a two-prong outlet, contact an electrician to replace it. Do not hold the plug with wet hands.
- Take the following precautions for the plug. Failure to comply with these precautions could result in sparks or fire: Do not insert the plug into an outlet with dust present. Insert the plug firmly into the outlet.
- Do not overload wall outlets, extension cords, or integral convenience receptacles. This can cause fire or electric shock.

- Do not place the projector where the cord can be walked on. This may result in fraying or damage to the plug.
- Unplug the projector from the wall outlet before cleaning. Use a damp cloth for cleaning. Do not use liquid or aerosol cleaners.
- Do not block the slots and openings in the projector case. They provide ventilation and prevent the projector from overheating. Do not operate the projector on a sofa, rug, or other soft surface, or in a closed-in cabinet unless proper ventilation is provided.
- Never push objects of any kind through cabinet slots. Never spill liquid of any kind into the projector.
- Except as specifically explained in this *User's Guide*, do not attempt to service this product yourself. Refer all servicing to qualified service personnel. Opening or removing covers may expose you to dangerous voltages and other hazards.
- Unplug the projector during lightning storms or when it will not be used for extended periods.
- Do not place the projector and remote control on top of heat-producing equipment or in a hot location.
- Unplug the projector from the wall outlet and refer servicing to qualified service personnel under the following conditions: When the power cord or plug is damaged or frayed. If liquid has been spilled into the projector, or if it has been exposed to rain or water. If it does not operate normally when you follow the operating instructions, or if it exhibits a distinct change in performance, indicating a need for service. If it has been dropped or the housing has been damaged.
- If you use the projector in a country other than where you purchased it, use the correct power cable for that country.

## *Remote Control Information*

You can operate the projector by remote control via a line-of-sight infrared (IR) receiver at the front and rear of the projector. The projector may not respond to remote control commands under the following conditions:

- There is an object between the remote control IR emitter and the IR receiver on the projector.
- Ambient light is too bright.
- Certain types of fluorescent lighting are used.
- A strong light source shines into the IR receiver.
- Other equipment that emits infrared energy, such as a radiant room heater, is in the room.

These conditions commonly cause problems for most infrared-controlled equipment. Try the following:

- The remote control batteries may be low on power; replace them.
- Dim the ambient lighting and/or turn off any fluorescent lights.
- Close any window coverings and/or move the projector out of direct sunlight.
- Turn off other equipment that emits infrared energy.

If the remote control still does not work properly, remember you can always control your computer-based presentation directly from the computer, even in an environment containing one of the conditions listed above.

## *Declaration of Conformity*

According to 47CFR, Part 2 and 15

Class B Personal Computers and Peripherals; and/or  
CPU Boards and Power Supplies used with Class B  
Personal Computers

We: EPSON AMERICA, INC.  
Located at: 3840 Kilroy Airport Way  
MS: 6-43  
Long Beach, CA 90806-2469  
Tel: (562) 290-5254

Declare under sole responsibility that the product identified herein, complies with 47CFR Part 2 and 15 of the FCC rules as a Class B digital device. Each product marketed, is identical to the representative unit tested and found to be compliant with the standards. Records maintained continue to reflect the equipment being produced can be expected to be within the variation accepted, due to quantity production and testing on a statistical basis as required by 47CFR §2.909. Operation is subject to the following two conditions: (1) this device may not cause harmful interference, and (2) this device must accept any interference received, including interference that may cause undesired operation.

Trade Name: EPSON  
Type of Product: LCD Projector  
Model: EMP-8100/ELP-8100  
EMP-9100/ELP-9100



# *FCC Compliance Statement*

## **For United States Users**

This equipment has been tested and found to comply with the limits for a Class B digital device, pursuant to Part 15 of the FCC Rules. These limits are designed to provide reasonable protection against harmful interference in a residential installation. This equipment generates, uses, and can radiate radio frequency energy and, if not installed and used in accordance with the instructions, may cause harmful interference to radio or television reception. However, there is no guarantee that interference will not occur in a particular installation. If this equipment does cause interference to radio and television reception, which can be determined by turning the equipment off and on, the user is encouraged to try to correct the interference by one or more of the following measures:

- Reorient or relocate the receiving antenna.
- Increase the separation between the equipment and receiver.
- Connect the equipment into an outlet on a circuit different from that to which the receiver is connected.
- Consult the dealer or an experienced radio/TV technician for help.

## **WARNING**

The connection of a non-shielded equipment interface cable to this equipment will invalidate the FCC Certification of this device and may cause interference levels which exceed the limits established by the FCC for this equipment. It is the responsibility of the user to obtain and use a shielded equipment interface cable with this device. If this equipment has more than one interface connector, do not leave cables connected to unused interfaces. Changes or modifications not expressly approved by the manufacturer could void the user's authority to operate the equipment.

## **For Canadian Users**

This Class B digital apparatus meets all requirements of the Canadian Interference-Causing Equipment Regulations.

*Cet appareil numérique de la classe B respecte toutes les exigences du Règlement sur le matériel brouilleur du Canada.*



# Index

## A

- A/V Mute
  - button, 52, 74, 91
  - menu option, 70
- About menu, 60, 75
- Accessories, 4 to 5, 92
- Adobe Acrobat Reader, 7
- Advanced menu, 60, 69, 71 to 72
- Air filter
  - cleaning, 78 to 79
  - replacing, 78 to 79
- ANSI lumens, 1, 93
- Arrow tool, using, 54
- Aspect ratio, 94
- Audio
  - adjusting volume, 51
  - cable, 10, 20, 23, 28, 32, 36 to 37
  - connecting desktop, 20, 28
  - connecting laptop, 23
  - connecting PowerBook, 32
  - menu, 59, 67
  - problems, 91
- Auto button, 47

## B

- Bar tool
  - changing, 68
  - using, 55
- Bass, 67
- Batteries, installing, 12, 86
- BNC
  - cable, 10, 11, 33, 37
  - format, 70
  - option, 70, 87
  - signal, 11
- Box tool
  - changing, 68
  - using, 54 to 55

- Brightness option, 64
- Brightness, projector, 93

## C

- Cables, 5, 9 to 11
- Camcorder, 1, 15
- Capture menu, 60, 72 to 73
- Capturing image, 72 to 74
- Carrying case, 4, 9, 82
- Case, cleaning, 78
- CE Marking, 95
- Ceiling mount, 4
- Ceiling, hanging the projector from, 72
- Cleaning
  - air filter, 78 to 79
  - lens, 77
  - projector case, 78
- Color menu option, 64
- Color noise, 1
- Color Setting option, 71
- Comp2 Sync Termination, 71
- Comp2/YCbCr button, 87, 91
- Component video, 35, 37
- Composite video, 35
- Computer connector pin assignments, 99
- Computer settings, saving, 66
- Computer video cable, 10, 17 to 18, 20 to 21, 24 to 25, 29 to 30
- Computer, adjusting projected image for, 63 to 65
- Connecting projector
  - to a BNC computer, 33
  - to a desktop Macintosh, 24 to 28
  - to a desktop PC, 17 to 20
  - to a DVI source, 33 to 34
  - to a high-end workstation, 34
  - to a laptop PC, 20 to 23
  - to a PowerBook, 29 to 32
  - to a video source, 35 to 37
- Connector pin assignments, 99

Contrast option, 64  
Contrast ratio, 93  
CRT/LCD, 43, 88  
Cursor speed, 69  
Cursor/stamp tool  
    changing, 68  
    using, 54

## D

Declaration of Conformity, 106  
Default settings, 76  
Desktop adapter, Macintosh, 10, 24 to 25,  
    29 to 30  
Desktop computer, connecting projector to,  
    17 to 20, 24 to 28  
Digital camera, 1, 15  
Digital noise reduction, 1  
Digital video cables, 5  
DIP switches, 25, 30  
Distance from projector to screen, 13 to 14,  
    100 to 102  
Drawing on the screen, 53 to 55  
Drawing tools, customizing, 68 to 69  
DVD, 1, 15, 35  
DVI, 11, 33 to 34

## E

Effect menu, 59, 68 to 69  
Electrical specifications, 95  
Electronic manuals, 7  
E-mail support, 92  
EMP Link V, 4, 10, 18 to 19, 22 to 23,  
    27 to 28, 31 to 32  
Enter button, 49 to 50  
Environmental specifications, 95  
EPSON  
    accessories, 4 to 5, 92  
    help, 92  
    PrivateLine Support, 3, 92  
    technical support, 3, 92  
Esc button, 50, 54 to 55, 62  
Extra long throw zoom lens, 4, 101  
E-Zoom button, 45, 50

## F

FCC compliance statement, 107  
Fixed short throw lens, 4, 102  
Fn key, 43, 88  
Focus ring, 44  
Focusing, 44  
Foot release levers, 46 to 47  
Freeze button, 52  
Frequency option, 75

## G

Gamma option, 64

## H

HDTV, 2, 35, 97  
Height of image, adjusting, 46 to 47  
Help button, 57  
Help system, using, 57  
Help, EPSON, 2 to 3, 92  
High-end workstation, 34

## I

Image  
    adjusting, 44 to 48, 63 to 65  
    capturing, 72 to 74  
    correcting shape of, 47, 89  
    height, adjusting, 46 to 47  
    help, 57  
    positioning, 46 to 47, 64  
    problems, 87 to 91  
    raising, 46 to 47  
    resizing, 45  
    shape, correcting, 47, 89  
    size and distance from screen, 13,  
        100 to 102  
    size range, 93  
    turning off, 52  
    zooming, 45, 50  
Internet, 92

## K

- Kensington security lock, 4
- Keystone button, 47, 89
- Keystone correction, 47, 70, 89, 94

## L

- Lamp
  - light, 56, 84 to 85
  - number of hours used, 75
  - replacing, 80 to 81
  - specifications, 94
  - timer, resetting, 82
- Lamp ON Time option, 75
- Language menu option, 71
- Language setting, 57
- Laptop computer
  - connecting to, 20 to 23, 29 to 32
  - displaying on, 43, 88, 90
- Lens
  - accessories, 4
  - cleaning, 77
  - extra long throw zoom, 4, 101
  - fixed short throw, 4, 102
  - long throw zoom, 4, 100 to 101
  - short throw zoom, 4, 102
  - specifications, 93
  - standard, 100
- Lens shift knob, 46
- Light button, 48
- Lights, status, 56, 84 to 85
- Lines, drawing on screen, 55
- Logo, saving on projector, 72 to 74
- Long throw zoom lens, 4, 100 to 101
- Lumens, 1, 93

## M

- Macintosh
  - adapter set, 10
  - connecting projector to, 24 to 32
  - desktop adapter, 10, 24 to 25, 29 to 30
  - monitor adapter, 10, 24 to 25
  - mouse cable, 10, 27 to 28, 31 to 32
  - serial cable, 10, 27 to 28, 31 to 32
  - video out cable, 29 to 30
- Main cable, 10, 18 to 19, 22 to 23, 27 to 28, 31 to 32
- Main menu, 60 to 62
- Manuals, 7
- Menus
  - About, 60, 75
  - Advanced, 60, 69, 71 to 72
  - Audio, 59, 67
  - Capture, 60, 72 to 73
  - changing settings, 59 to 62
  - Effect, 59, 68 to 69
  - Main, 60 to 62
  - Reset All, 60, 76
  - Setting, 60, 69 to 70
  - User's Logo, 72 to 73
  - using, 59 to 62
  - Video, 59, 63 to 65
- Monitor adapter, Macintosh, 10, 24 to 25
- Monitor cable, 17, 24 to 26
- Monitor Out pin assignments, 99
- Mouse cable
  - Macintosh, 10, 27 to 28, 31 to 32
  - PS/2, 10, 18 to 19, 22 to 23
  - serial, 10, 19

## N

No Signal message, 40 to 42, 70, 74, 87  
Noise reduction, 1  
NTSC, 2, 35, 95 to 97  
Numbered buttons on remote control, 53

## O

Online Help, 2  
Options for the projector, 4 to 5

## P

P in P  
    button, 52 to 53  
    option, 70  
PAL, 2, 35, 95 to 97  
PC serial cable, 10, 17 to 19, 22 to 23  
PC serial mouse cable, 10, 19  
Picture in picture, 52 to 53, 70  
Pin assignments, connector, 99  
Position option, 64, 66  
Positioning image, 44 to 47, 64  
Positioning the projector, 13 to 14, 100 to 102  
Power  
    button, 40, 58, 87  
    consumption, 95  
    cord, 40  
    light, 40 to 42, 56, 58, 84 to 85  
    supply, 95  
PowerBook, connecting projector to, 29 to 32  
Presenters Online, 2, 92  
Preset  
    button, 66  
    option, 65 to 66  
PrivateLine Support, 3, 92  
Projection lamp light, 56, 84 to 85

## Projector

    carrying case, 4, 9, 82  
    cleaning, 78  
    connecting, 15 to 37  
    distance from screen, 13 to 14, 93,  
        100 to 102  
    feet, 46  
    hanging from the ceiling, 72  
    lamp specifications, 94  
    positioning, 13 to 14, 100 to 102  
    problems, 84 to 85  
    registering, 3  
    resolution, 1, 64, 66, 75, 93  
    setting up, 9 to 37  
    shutting off, 58  
    status lights, 84 to 85  
    transporting, 82  
    turning off, 58  
    turning on, 40  
    unpacking, 9 to 11  
    viewing information, 75  
Projector case, cleaning, 78  
Prompt menu option, 70  
PS/2 mouse cable, 10, 18 to 19, 22 to 23

## R

Raising image, 46 to 47  
RCA  
    audio cable, 10, 36 to 37  
    video cable, 10, 35 to 36  
Rear projection, 72  
Refresh Rate option, 75  
Registration, 3  
Remote control  
    information, 105  
    light button, 48  
    problems, 86, 105  
    specifications, 94  
    turning on, 48  
    using, 48 to 50  
    using as wireless mouse, 49 to 50

Replacing the air filter, 78 to 79  
Replacing the lamp, 80 to 81  
Reset All menu, 60, 76  
Resetting lamp timer, 82  
Resetting menu options, 62  
Resize button, 45  
Resizing image, 45  
Resolution, 1, 64, 66, 75, 93

## S

Safety instructions, 103 to 104  
Screen image, *See* Image  
Screen logo, 72 to 74  
Screen, distance from projector, 13 to 14,  
100 to 102  
SECAM, 2, 35, 95 to 97  
Security lock, 4, 14  
Serial cable  
    Macintosh, 10, 27 to 28, 31 to 32  
    PC, 10, 17 to 19, 22 to 23  
Setting menu, 60, 69 to 70  
Sharpness option, 64  
Short throw zoom lens, 4, 102  
SizeWise, 1  
Sleep mode, 43, 58, 70  
Smooth motion, 1, 65  
Sound  
    adjusting the bass, 67  
    adjusting the treble, 67  
    adjusting volume, 51, 67  
    help, 57  
    problems, 91  
    turning off, 52  
Source, selecting, 51  
Speakers  
    adjusting the bass, 67  
    adjusting the treble, 67  
    adjusting the volume, 67  
    specifications, 94  
Special effects buttons, 53 to 55

Specifications  
    electrical, 95  
    environmental, 95  
    general, 93 to 94  
    lamp, 94  
    lens, 93  
    remote control, 94  
    safety, 95

Spotlight tool  
    changing, 68  
    using, 55

Stamp tool  
    changing, 68  
    using, 54

Startup screen  
    creating, 72 to 74  
    menu option, 71

Status lights, 56, 84 to 85

Stopping action, 52

Support, 3, 92

SVGA, 1, 95 to 97

S-Video  
    button, 51  
    cable, 11, 35, 37  
    signal, 11, 35

SXGA, 1, 95 to 97

Sync Mode option, 75

Sync option, 64

Sync Polarity option, 75

Synchronization, adjusting, 47 to 48, 64, 90

## T

Technical support, 3, 92

Temperature  
    light, 56, 84 to 85  
    requirements, 95

Tint option, 64

Tone, adjusting, 67

Tracking option, 64

Tracking Sync signal, 66

Tracking, adjusting, 47 to 48, 64, 90

Transporting projector, 82

Trapezoid image, 89

Treble, 67

Troubleshooting  
  image and sound problems, 87 to 91  
  projector problems, 84 to 85  
  remote control problems, 86  
Turning off picture, 52  
Turning off projector, 58  
Turning on projector, 40

## U

Unpacking projector, 9 to 11  
USB cable, 10, 18 to 19, 27  
User's Logo menu, 72 to 73  
UXGA, 1, 95 to 97

## V

VCR, 1, 35 to 37  
VGA, 1, 95 to 97  
Video  
  button, 51, 87, 91  
  display settings, viewing, 75  
  displaying source, 75  
  formats, 95 to 97  
  menus, 59, 63 to 65  
  port pin assignments, 99  
  selecting source, 51  
  signal, 65  
Video source, connecting projector to,  
  35 to 37  
Video-out cable, Macintosh, 11, 29 to 30  
Volume  
  adjusting, 51, 67  
  button, 51

## W

Warning lights, 56, 84 to 85  
Warranty, 3  
Workstations, connecting projector to, 34  
World Wide Web, 92

## X

XGA, 1, 95 to 97

## Z

Zoom lens, *see* Lens  
Zoom ratio, 94  
Zoom ring, 45  
Zooming image, 45, 50